

## Technical data

	Filter class	30 dB(A)	35 dB(A)	Boost
Maximum capacity <sup>A</sup>	ePM <sub>10</sub> 50%	256 m <sup>3</sup> /h	334 m <sup>3</sup> /h	344 m <sup>3</sup> /h
	ePM <sub>1</sub> 55%	251 m <sup>3</sup> /h	330 m <sup>3</sup> /h	340 m <sup>3</sup> /h
	ePM <sub>1</sub> 80%	231 m <sup>3</sup> /h	316 m <sup>3</sup> /h	330 m <sup>3</sup> /h
Throw (0,2 m/s) <sup>B</sup>	ePM <sub>10</sub> 50%	4.5 m	5.6 m	5.8 m
	ePM <sub>1</sub> 55%	4.5 m	5.6 m	5.8 m
	ePM <sub>1</sub> 80%	4.1 m	5.4 m	5.6 m
Operating range (max.capacity), outside temperature		-15 °C - 40 °C		
Supply air filter		ePM <sub>10</sub> 50%, ePM <sub>1</sub> 55% or ePM <sub>1</sub> 80%		
Extract air filter		ePM <sub>10</sub> 50%		
Dimensions (WxHxD)		2055 x 358 x 1100 mm		
Weight: complete standard air handling unit excl. panels / panels		232 kg / 6 kg		
Weight: casing incl. middle steel plate		190 kg		
Weight: service covers (3 pcs.) / steel plates (2 pcs.)		24 kg / 18 kg		
Color: casing / panels and service cover		RAL 9005 (Jet Black) / RAL 9010 (Pure white)		
Counterflow heat exchanger		Aluminium		
Air leakage classification cf. EN 1886 / EN 13141-7		Class L2 / A1		
Air leakage classification, main damper, cf. EN 1751		Class 3		
IP code		10		
Duct connection		Ø200 mm		
Condensate pumps: capacity / lifting height (at 5 l/h)		10 l/h / 6 m		
Condensate drain hose: internal diameter / external diameter		Ø6 mm / Ø9 mm		
Supply voltage		220-240V/50Hz, ~1N+PE		
Maximum power (including heat pump)		2560 W		
Maximum current (including heat pump)		11.2 A		
Power factor (including heat pump)		0,92		
Maximum fuse		16 A, 1 phase, type C		
Leakage current AC / DC		6 mA / 0.04 mA		
Recommended residual current circuit breaker (RCCB)		Type B		

<sup>A</sup> All measurements were performed in a normal operating mode in a standard installation in a test room, dimensioned 8.0 m x 10.0 m x 2.5 m with room attenuation of 8 dB(A).

<sup>B</sup> The throw is measured with a 3-5°C subcooled supply air in a test room, dimensioned 8.0 m x 10.0 m x 2.5 m.

## Electrical heating surfaces

	Heating surface 1	Heating surface 2
Heat output	1150 W	1150 W
Nominal current	5 A	5 A
Thermal circuit breaker, manual reset	100°C	100°C

## Heating and cooling

Heating capacity ventilation, 7 °C (outside temperature) <sup>C</sup>	4000 W
Heating capacity recirculation, 7 °C (outside temperature) <sup>C</sup>	3000 W
Cooling capacity ventilation, 35 °C (outside temperature) <sup>C</sup>	1800 W
Cooling capacity recirculation, 35 °C (outside temperature) <sup>C</sup>	1230 W
Heat output recirculation, -15 °C (outside temperature)	2300 W
COP (heating) recirculation	3.7
EER (cooling) recirculation	3.0
SCOP & SEER	Please refer to Appendix A
Materials (heat pump): pipes / fins	Copper / Aluminium
Refrigerant / GWP <sup>D</sup>	R290 / 0.02
Filling	330 g

<sup>C</sup> cf. DS/EN 308 and DS/EN 14825.

<sup>D</sup> cf. (EU) 2024/573.

## Capacity at 30 dB(A) sound pressure level<sup>A</sup>

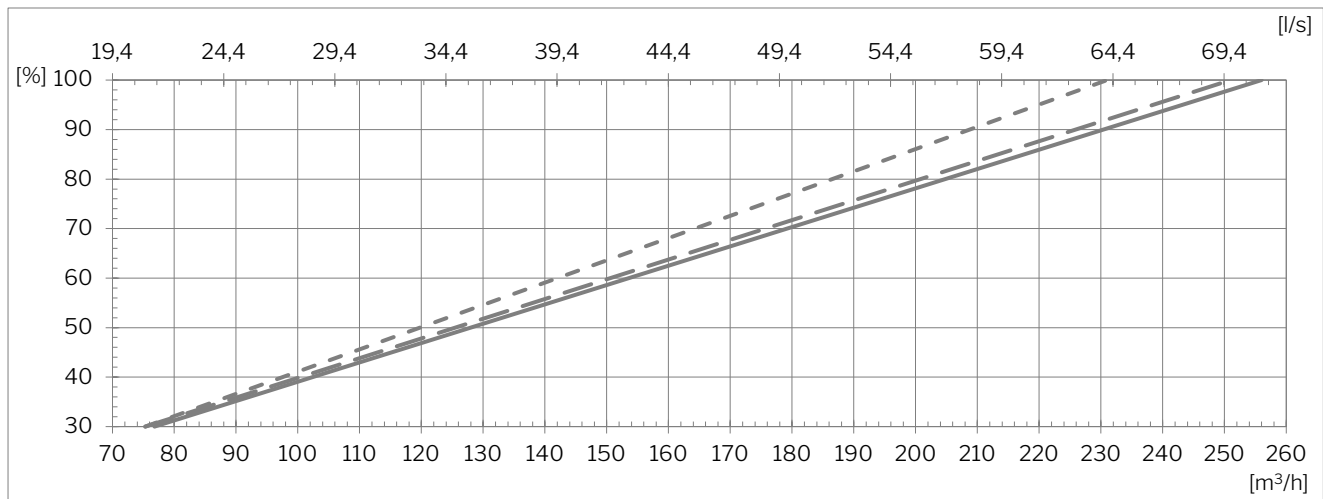

- Supply air filter ePM<sub>10</sub> 50% + extract air filter ePM<sub>10</sub> 50%
- Supply air filter ePM<sub>1</sub> 55% + extract air filter ePM<sub>10</sub> 50%
- Supply air filter ePM<sub>1</sub> 80% + extract air filter ePM<sub>10</sub> 50%

## Capacity at 35 dB(A) sound pressure level<sup>A</sup>

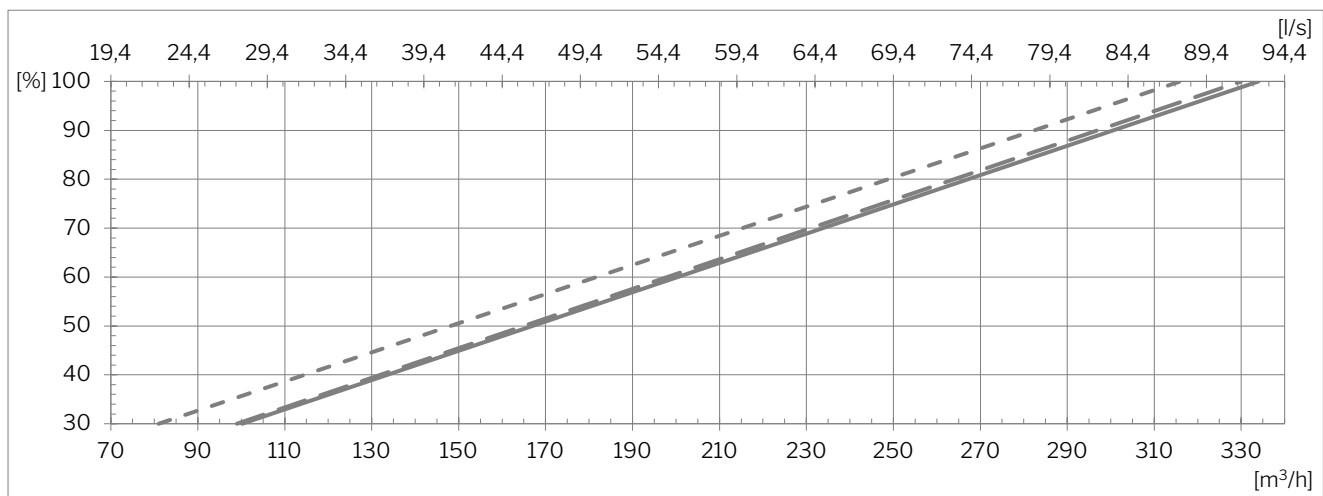

- Supply air filter ePM<sub>10</sub> 50% + extract air filter ePM<sub>10</sub> 50%
- Supply air filter ePM<sub>1</sub> 55% + extract air filter ePM<sub>10</sub> 50%
- Supply air filter ePM<sub>1</sub> 80% + extract air filter ePM<sub>10</sub> 50%

## SFP with supply air filter ePM<sub>10</sub> 50% + extract air filter ePM<sub>10</sub> 50%

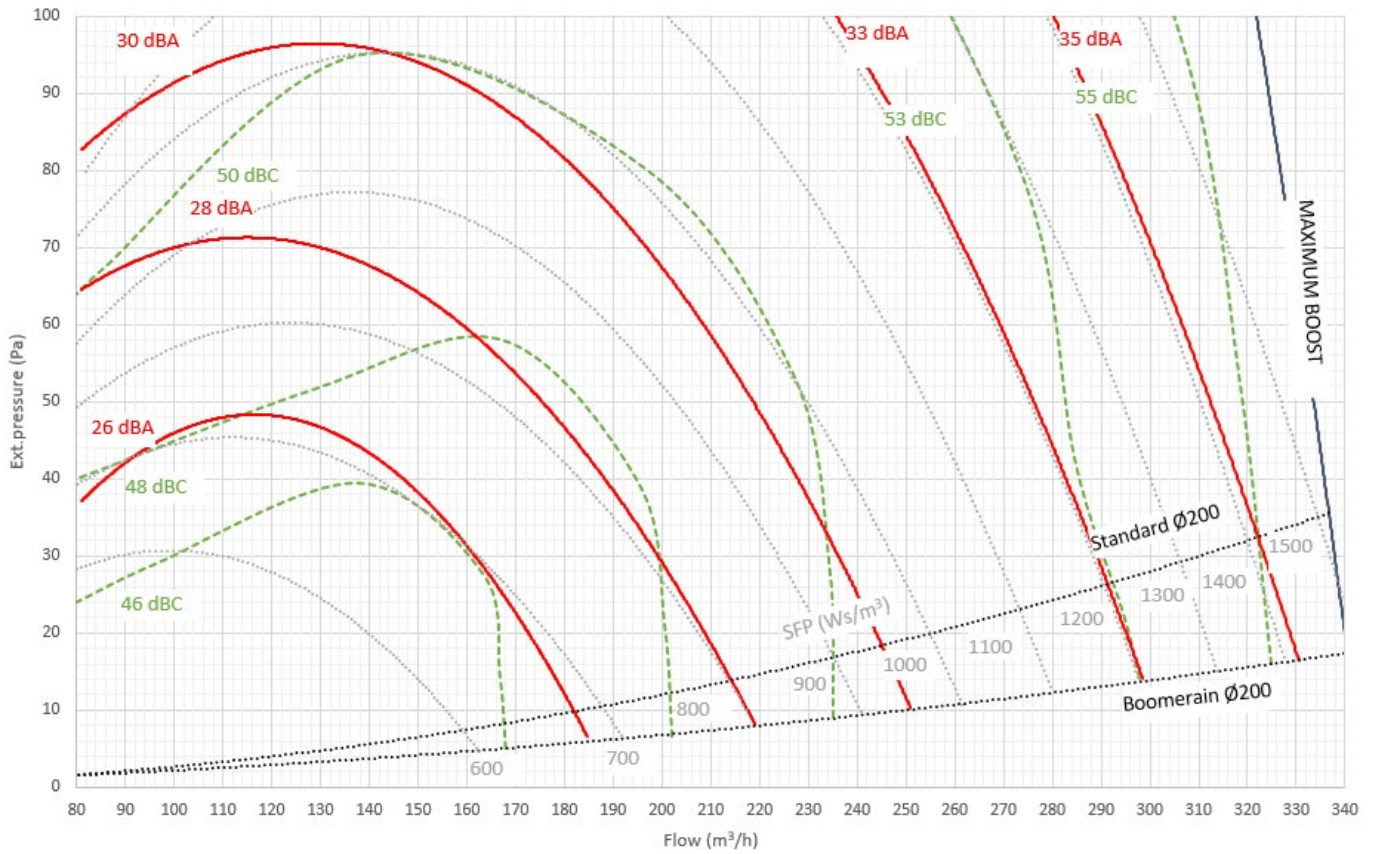

## SFP with supply air filter ePM<sub>1</sub> 55% + extract air filter ePM<sub>10</sub> 50%

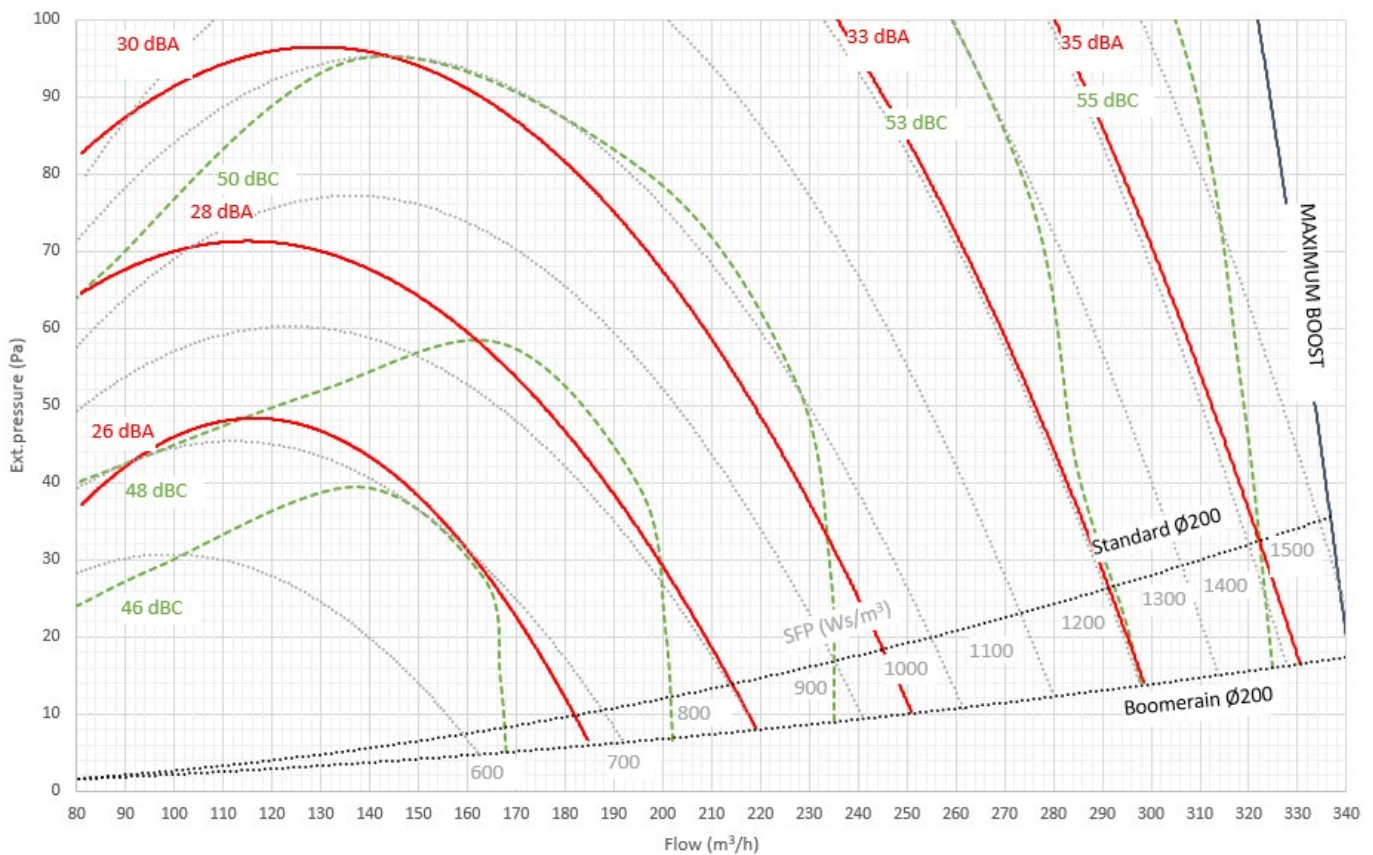

SFP with supply air filter ePM<sub>1</sub> 80% + extract air filter ePM<sub>10</sub> 50%

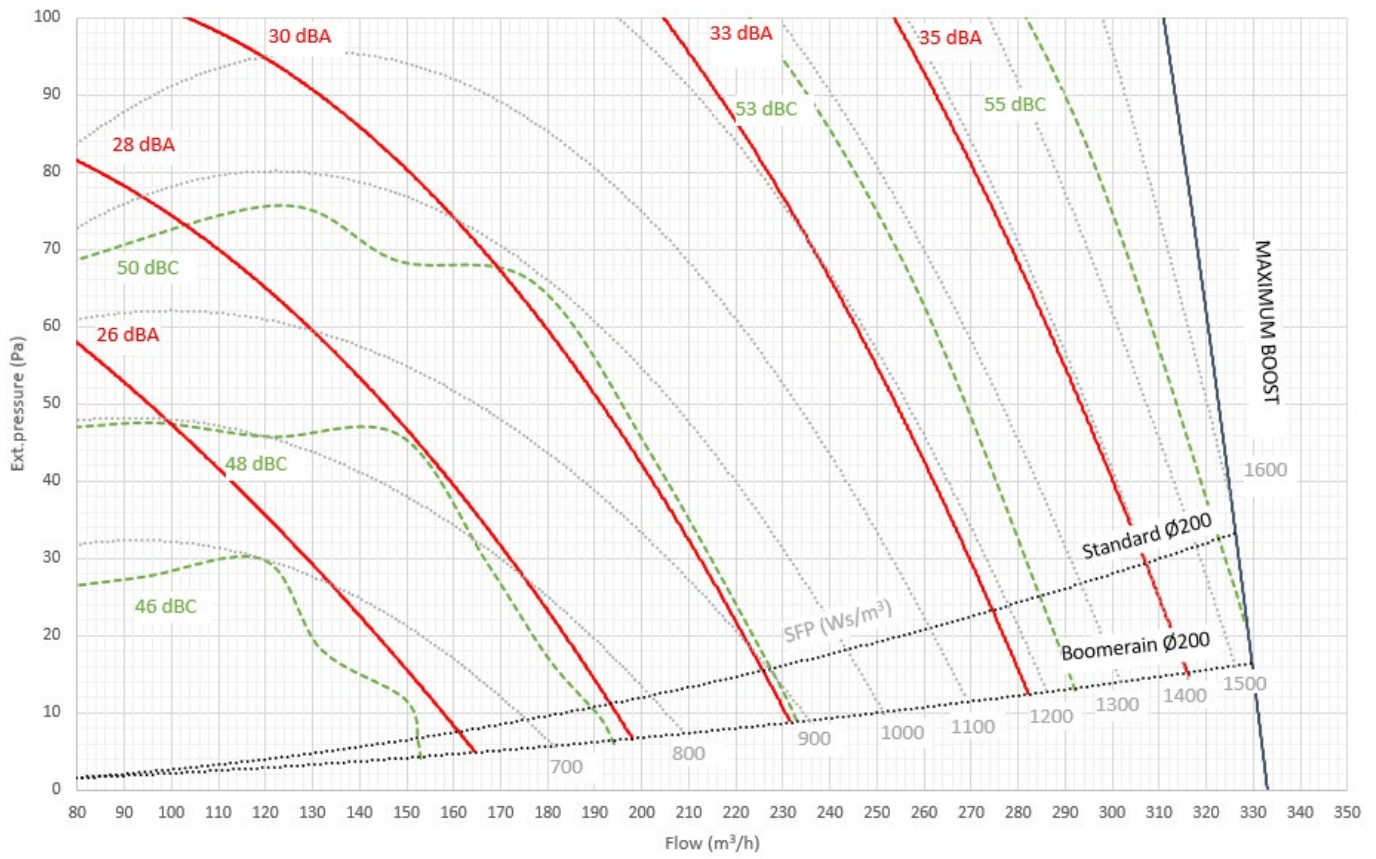

## A-weighted sound pressure level $L_{pA}$ acc. to Airmaster reference situation<sup>E</sup>

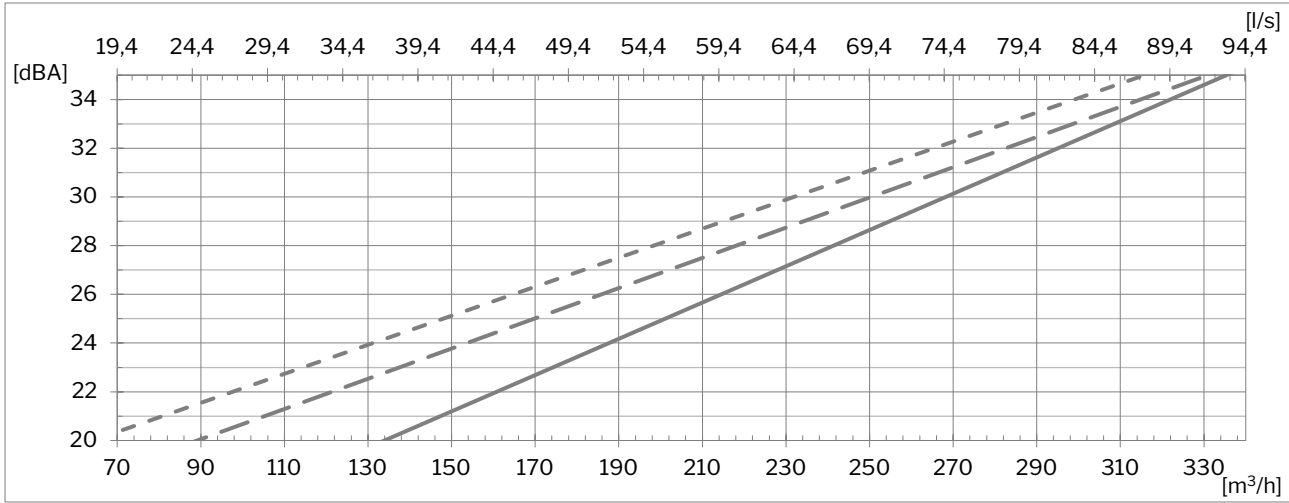

— Supply air filter ePM<sub>10</sub> 50% + extract air filter ePM<sub>10</sub> 50%

--- Supply air filter ePM<sub>1</sub> 55% + extract air filter ePM<sub>10</sub> 50%

--- Supply air filter ePM<sub>1</sub> 80% + extract air filter ePM<sub>10</sub> 50%

## Temperature efficiency acc. to EN 308

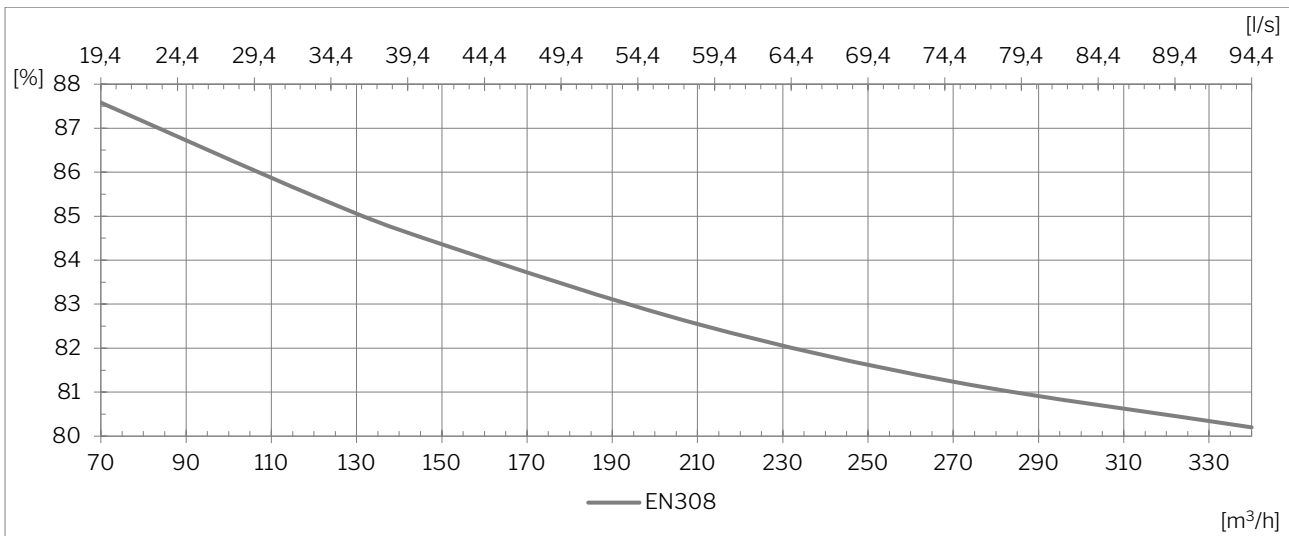

<sup>E</sup> The sound pressure level is measured at a height of 1.2 m at a horizontal distance of 1 m from the air handling unit.

## Power consumption

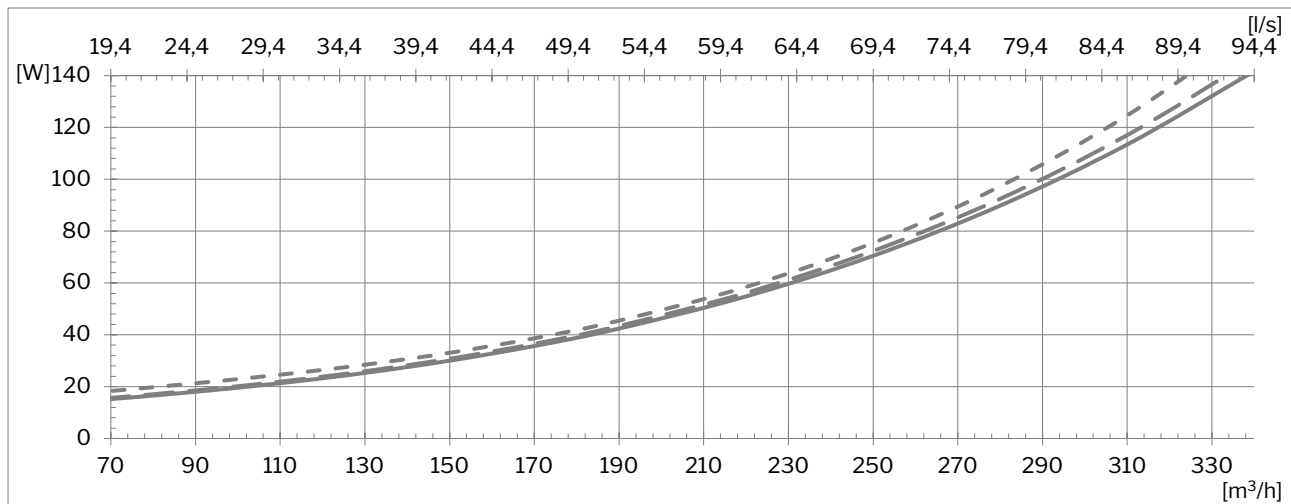

- Supply air filter ePM<sub>10</sub> 50% + extract air filter ePM<sub>10</sub> 50%
- Supply air filter ePM<sub>1</sub> 55% + extract air filter ePM<sub>10</sub> 50%
- .- Supply air filter ePM<sub>1</sub> 80% + extract air filter ePM<sub>10</sub> 50%

## SFP<sup>F</sup>

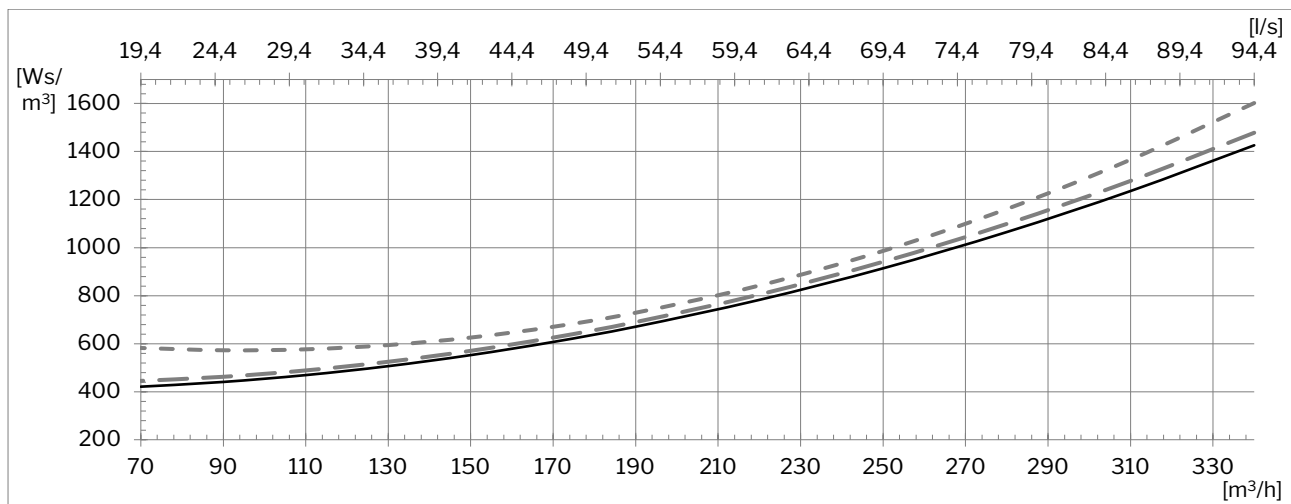

- Supply air filter ePM<sub>10</sub> 50% + extract air filter ePM<sub>10</sub> 50%
- Supply air filter ePM<sub>1</sub> 55% + extract air filter ePM<sub>10</sub> 50%
- .- Supply air filter ePM<sub>1</sub> 80% + extract air filter ePM<sub>10</sub> 50%

<sup>F</sup> The SFP calculation includes power consumption for operating fans but not controls, display panels, etc.

# Throw (0.2 m/s)

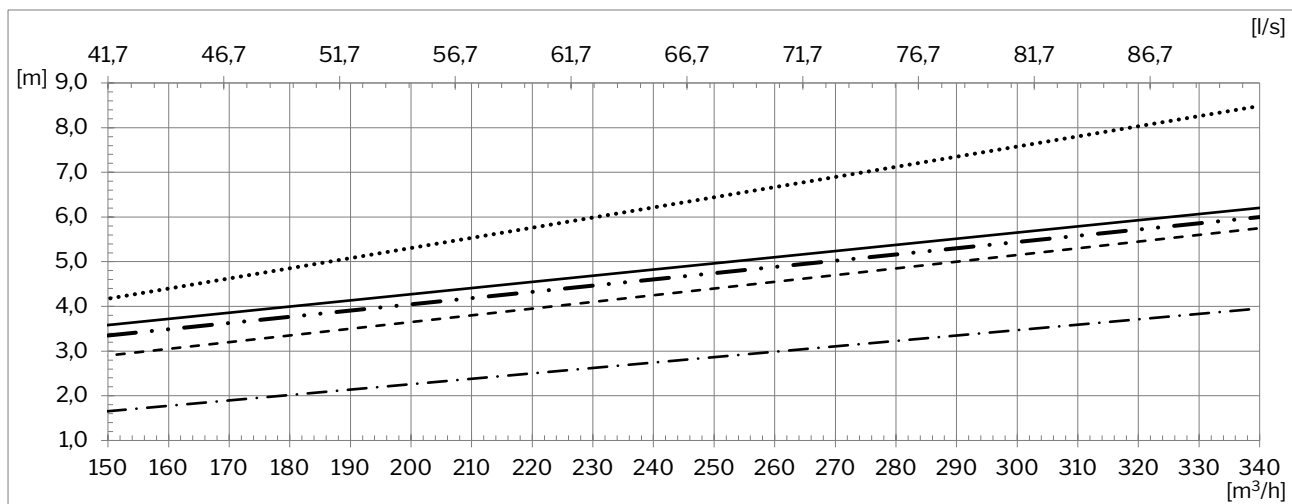

- ..... Reduced diffuser area. 0°/0° blade angle
- 0°/0° blade angle
- - - - 45°/45° blade angle. Standard factory setting
- . . . 60°/60° blade angle
- - - - - Asymmetric. -45°/60° blade angle

Reduced diffuser area  
0°/0° blade angle

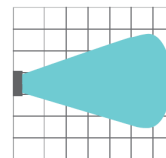

0°/0° blade angle

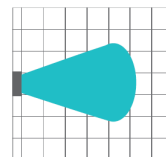

45°/45° blade angle  
Standard factory setting

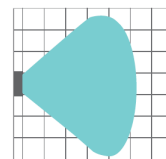

60°/60° blade angle

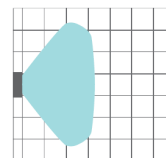

Asymmetric  
-45°/60° blade angle

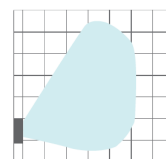



# Version overview

## Exhaust and supply:

**H:** horizontal



HH



## Inlet and extract:

**B:** bottom

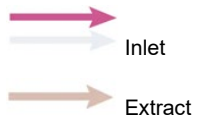

BB



## Standards and options

Counterflow heat exchanger (Aluminium)	✓	Supply air filter ePM <sub>10</sub> 50%	opt.
Motor-driven bypass	✓	Supply air filter ePM <sub>1</sub> 55%	opt.
Motor-driven supply air damper	✓	Supply air filter ePM <sub>1</sub> 80%	si
Motor-driven extract air damper	✓	Extract air filter ePM <sub>10</sub> 50%	✓
Electric heating surfaces	✓	LED (operating mode indicator)	✓
Condensate pump	✓	Wall/ceiling bracket	✓
Electronic humidity sensor (built-in)	✓	External connection module	opt.
PIR/motion sensor (wall mounted)	opt.	Airmaster Airlinq® Online	opt.
PIR/motion sensor (integrated)	opt.	Airlinq® Online API	opt.
CO <sub>2</sub> sensor (wall mounted)	opt.	Bluetooth app	✓
CO <sub>2</sub> sensor (integrated)	✓		
Propane sensor (integrated)	✓		

✓: standard   opt.: optional   si: special item

# Schematic sketch

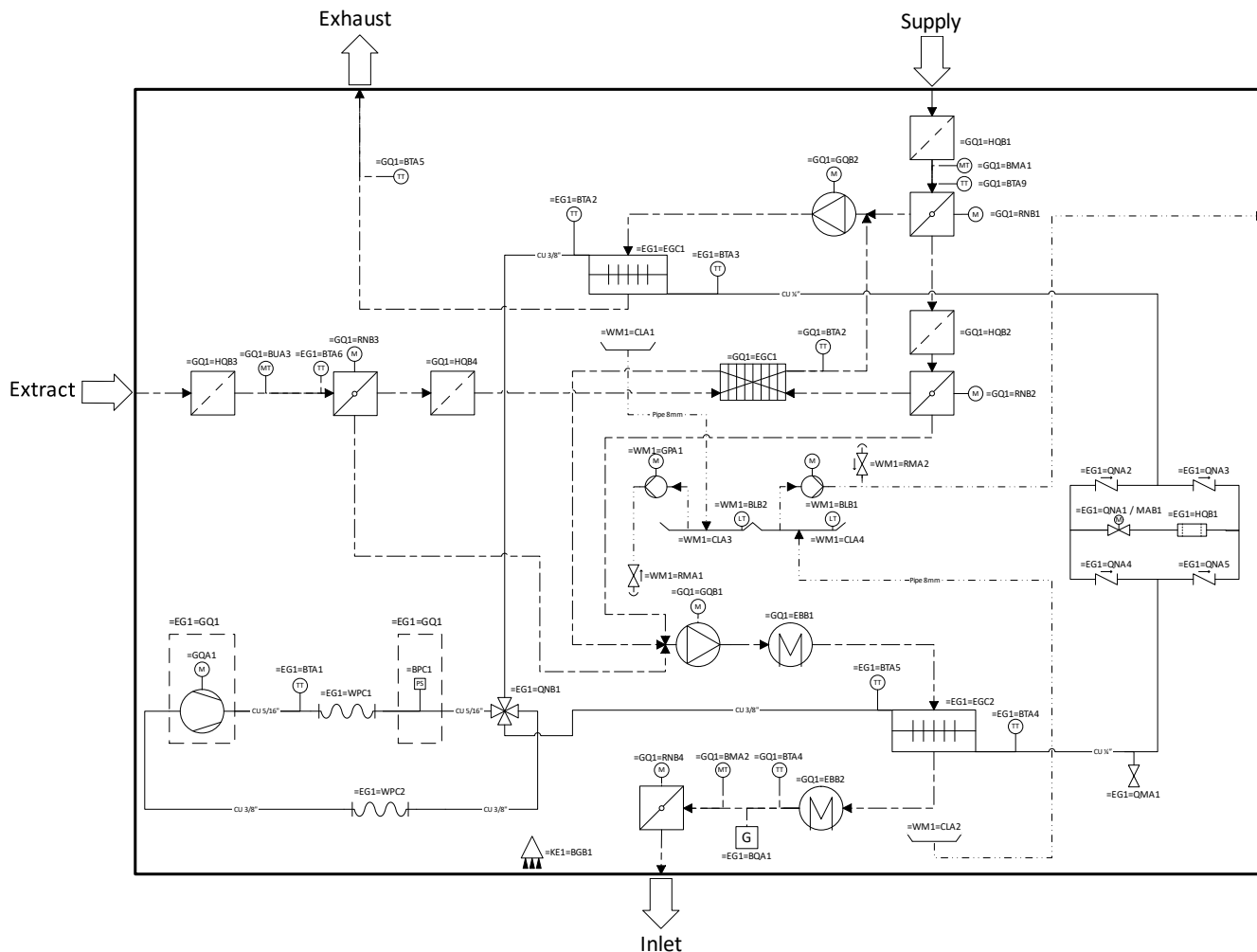

## Component designation:

=EG1 Heat pump system  
 =EG1=GQ1 Compressor system  
 =GQ1 Ventilation system  
 =WM1 Condensate system

=BGB PIR  
 =BLB Level sensor  
 =BMA Humidity sensor  
 =BPA Pressure transmitter  
 =BPC Pressure switch  
 =BQA Propane sensor  
 =BTA Temperature sensor  
 =BUA Humidity/CO<sub>2</sub> sensor

=CLA Condensate tray  
 =EBB Heating surface  
 =EGC Heat exchanger  
 =GPA Condensate pump  
 =GQA Compressor  
 =GQB Fan  
 =HQB Filter

=QMA Filling valve  
 =QNA Valve  
 =QNB 4-way valve  
 =RNB Damper  
 =WPC Flexible connection