

Data Sheet AM 1000

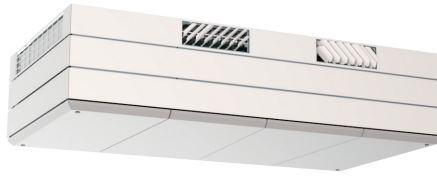

Technical data	Filter class	30 dB(A)	35 dB(A)
Maximum capacity ¹	ePM ₁₀ 50%	950 m ³ /h	1050 m ³ /h
	ePM ₁ 55%	926 m ³ /h	1024 m ³ /h
	ePM ₁ 80%	903 m ³ /h	998 m ³ /h
Throw (0,2 m/s) ²	ePM ₁₀ 50%	8,0 m	9,5 m
	ePM ₁ 55%	7,6 m	9,1 m
	ePM ₁ 80%	7,2 m	8,7 m
Supply air filter	ePM ₁₀ 50%, ePM ₁ 55% or ePM ₁ 80%		
Extract air filter	ePM ₁₀ 50%		
Dimensions (WxHxD)	2325 x 561 x 1283 mm		
Weight: Standard unit complete; centre -, left -, right -, front module; service covers	301,5 kg; 131 kg; 61 kg; 36 kg; 19 kg; 35 kg		
Color, Panel / Color, Case	RAL 9010 (white) / RAL 7024 (grey)		
Counterflow heat exchanger	Aluminium		
Air leakage classification cf. EN1886/EN13141-7	Class L2 / A1		
Air leakage classification, main damper, cf. EN1751	Class 3		
IP code	10		
Duct connection ³	Ø315 mm		
Condensate pump (capacity/lifting height at 5 l/h)	10 l/h / 6 m		
Condensate drain hose internal/external diameter	Ø6 mm / Ø9 mm		
Supply voltage: single-phase ⁴ ; three-phase ⁴	220-240V/50Hz, ~1N+PE; 220-240V/50Hz, ~3N+PE (400V connection)		
Nominal power consumption at 30 dB(A) / 35 dB(A)	280 W / 305 W		
Nominal current at 30 dB(A) / 35 dB(A)	2,0 A / 2,2 A		
Power factor	0,6		
Maximum fuse	16 A (1 phase, type B) 3 x 16 A (3 phases, type B). When choosing a pre-heating surface, a 3-phase connection must be used		
Leakage current	≤ 4 mA		
Recommended residual current circuit breaker (RCCB)	Type B		
Electrical heating surfaces	Preheating surface	Comfort heating surface	
Heat output	2300 W	1500 W	
Nominal current	10 A	6,5 A	
Thermal cutout, automatic reset	50 °C	50 °C	
Thermal cutout, manual reset	100 °C	100 °C	
Water heating surface			
Nominal heat output ⁵	2540 W		
Connection dimension	1/2" (DN 15)		
Materials pipes/fins	Copper/aluminum		
Opening/closing time, motor valve	60 s		
Maximum operating temperature	90 °C		
Maximum operating pressure	5 bar		

¹ All measurements were performed with an AM 1000 HH TT in normal operating mode in a standard installation, using the wall grilles Ø315 recommended by Airmaster with a room attenuation of 9 dB.

² The throw was measured with a 2 °C subcooled supply air. The setting is adaptable, see page 5.

³ Horizontal supply/exhaust using Airmaster Boomerain® Ø315 or with Ø400 mm wall grilles.

⁴ The supply voltage can be limited to a single-phase, connected to L1. Only for air handling units without electric heating surface or only with electric comfort heating surface.

⁵ Heat output for maximum capacity at supply/exhaust temperature 60/40 °C and a liquid flow of 112 l/h.

Capacity with ePM₁₀ 50% / ePM₁₀ 50% filters⁶

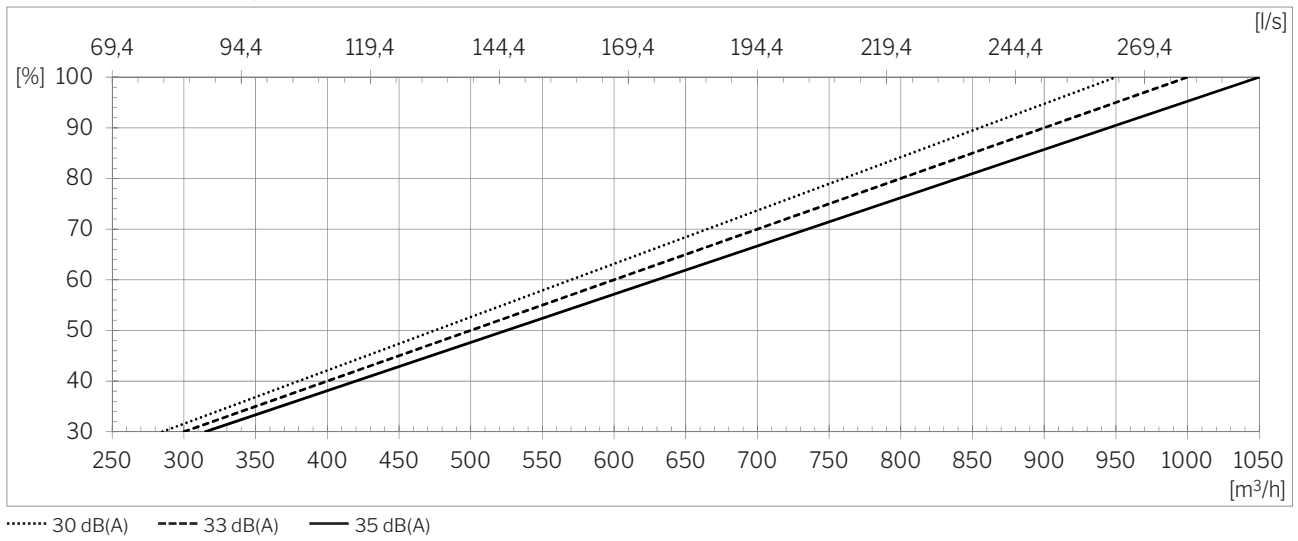

Capacity with ePM₁ 55% / ePM₁₀ 50% filters⁶

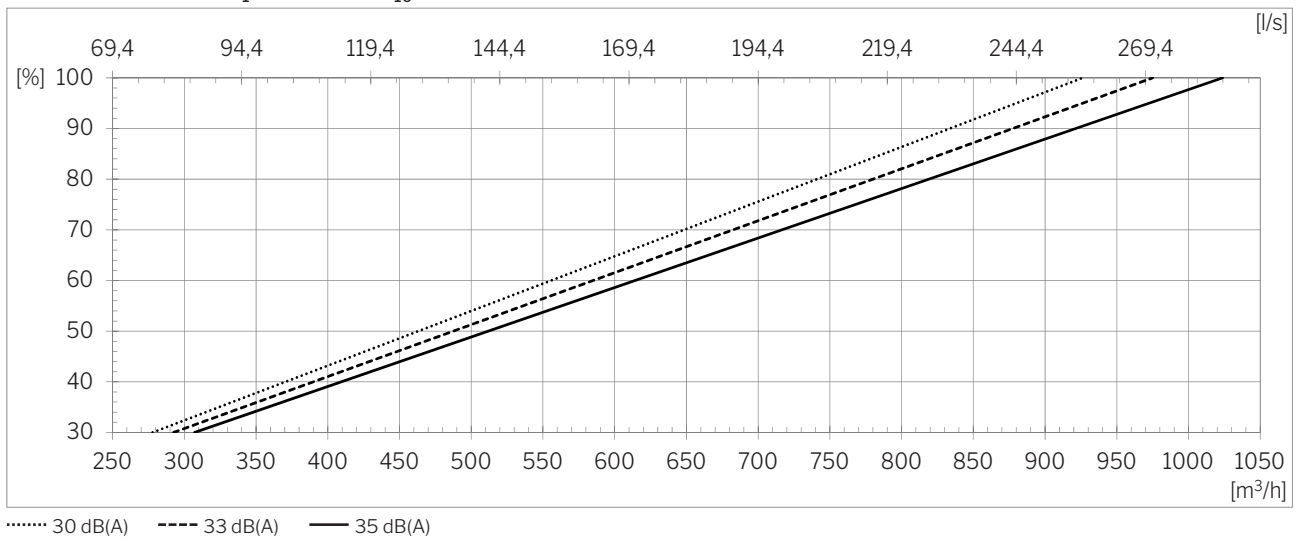

Capacity with ePM₁ 80% / ePM₁₀ 50% filters⁶

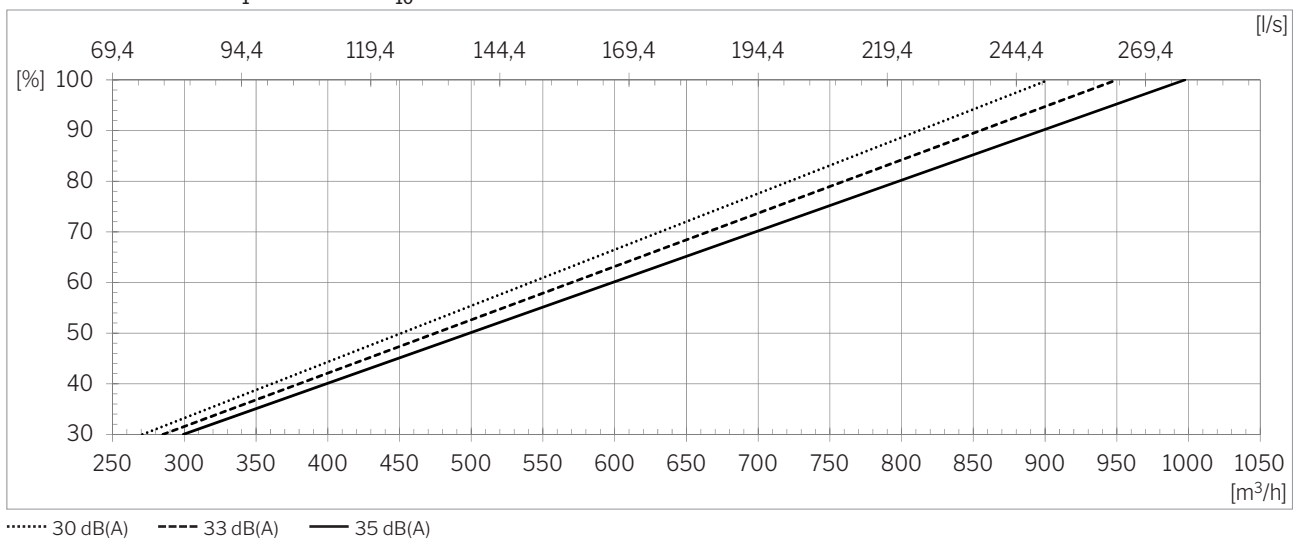

⁶ All measurements were performed with an AM 1000 HH TT in normal operating mode in a standard installation, using the wall grilles Ø315 recommended by Airmaster with room attenuation of 9 dB.

SFP with ePM₁₀ 50% / ePM₁₀ 50% filters⁷

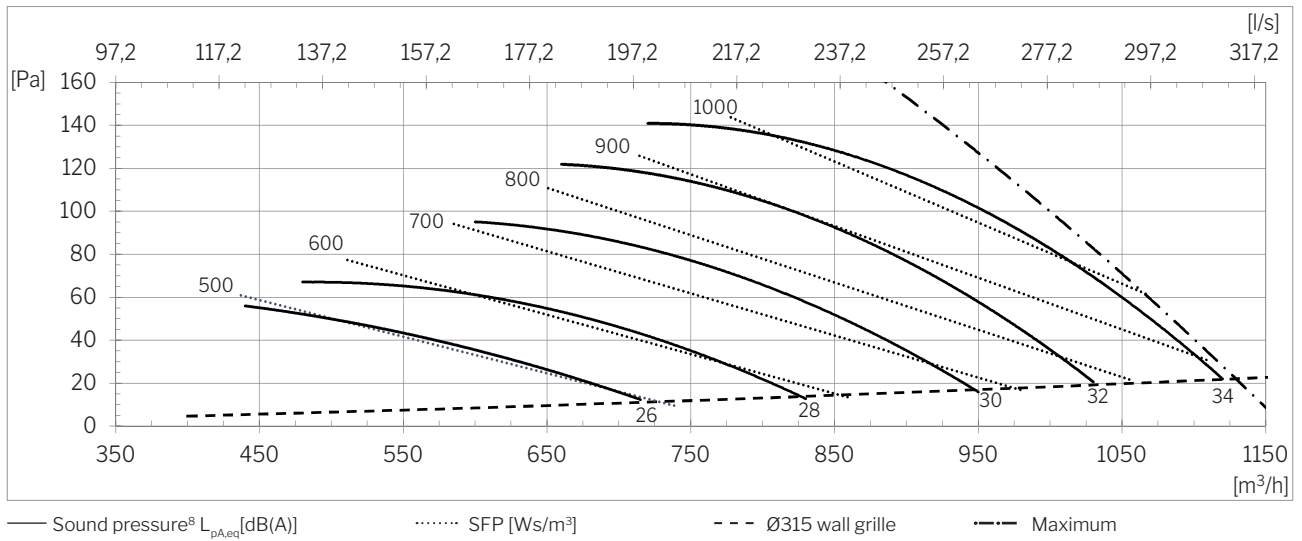

SFP with ePM₁ 55% / ePM₁₀ 50% filters⁷

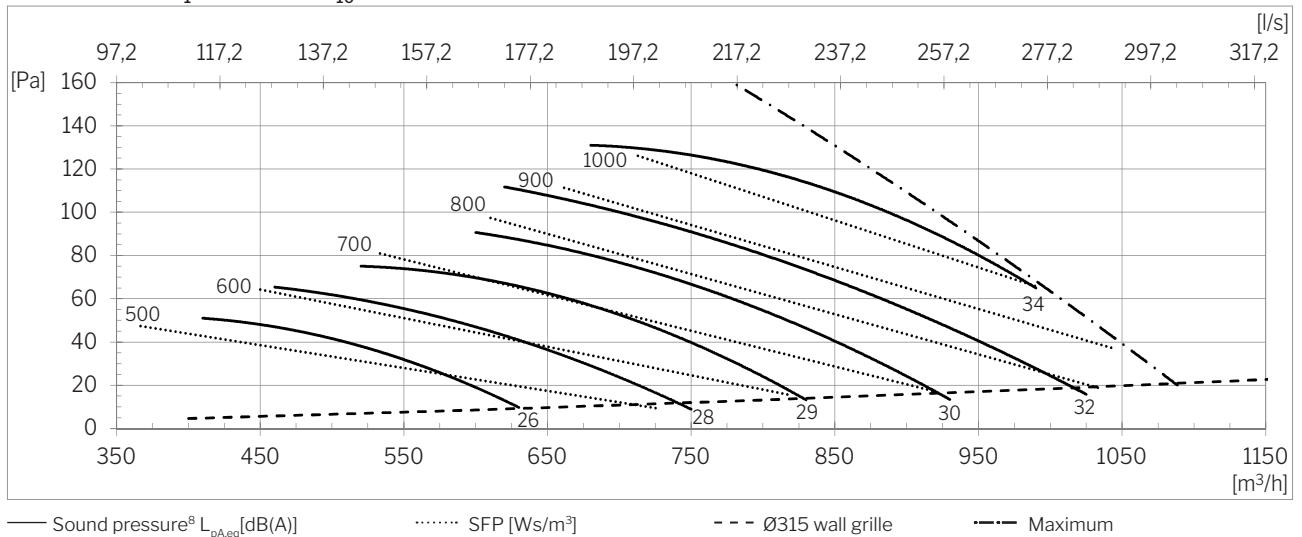

SFP with ePM₁ 80% / ePM₁₀ 50% filters⁷

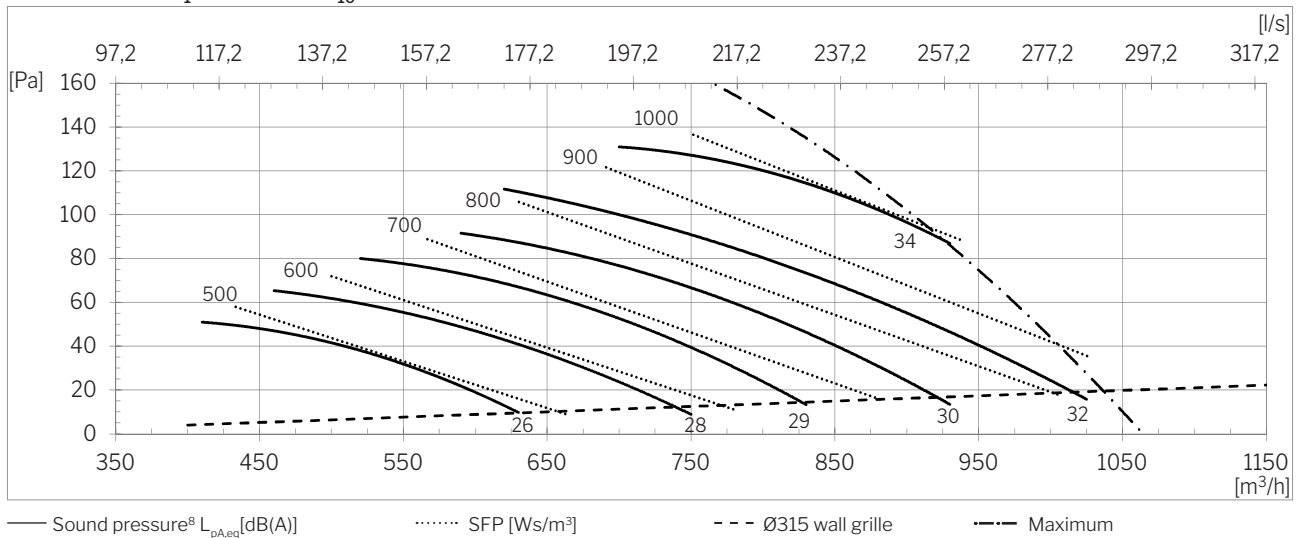

⁷ All measurements were performed with an AM 1000 HH TT in normal operating mode in a standard installation, using the wall grilles Ø315 recommended by Airmaster with room attenuation of 9 dB.

⁸ Sound pressure level L_{pA,eq} was measured at a height of 1.2 m with a horizontal clearance from the unit of 1 m at a room attenuation of 9 dB.

Sound power level, LWA [dB(A)], acc. ISO 9614-1

Data is for the entire unit (including top) at a flow of 950 m³/h with ePM₁₀ 50% / ePM₁₀ 50% filters and Ø315 wall grille. A simplified calculation model that assumes a point source may result in an over-estimation of the sound pressure for AM 1000, especially if absorbent surfaces are located close to the unit.

Frequency [Hz]	63	125	250	500	1000	2000	4000	8000	Total
L _{WA} [dB(A)]	31,2	38,3	38,2	36,7	31,6	23,4	14,1	7,7	43,2

Temperature efficiency, acc. to EN 308

EN 308 conditions: Balanced operation; Room air: 25 °C, 28 % RH; Outdoor air: 5 °C, 50 % RH.

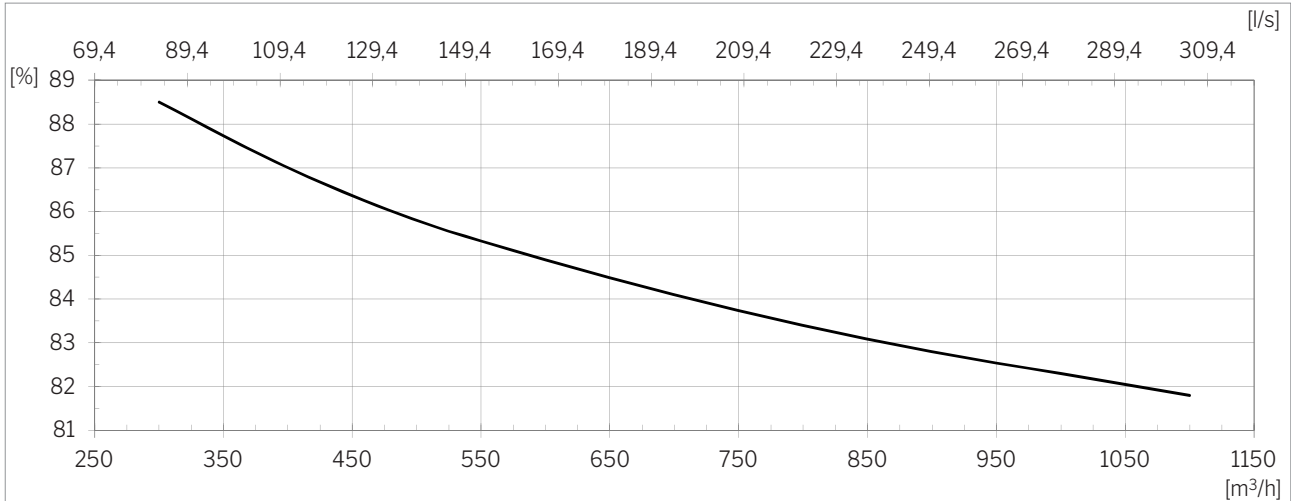

Power consumption⁹

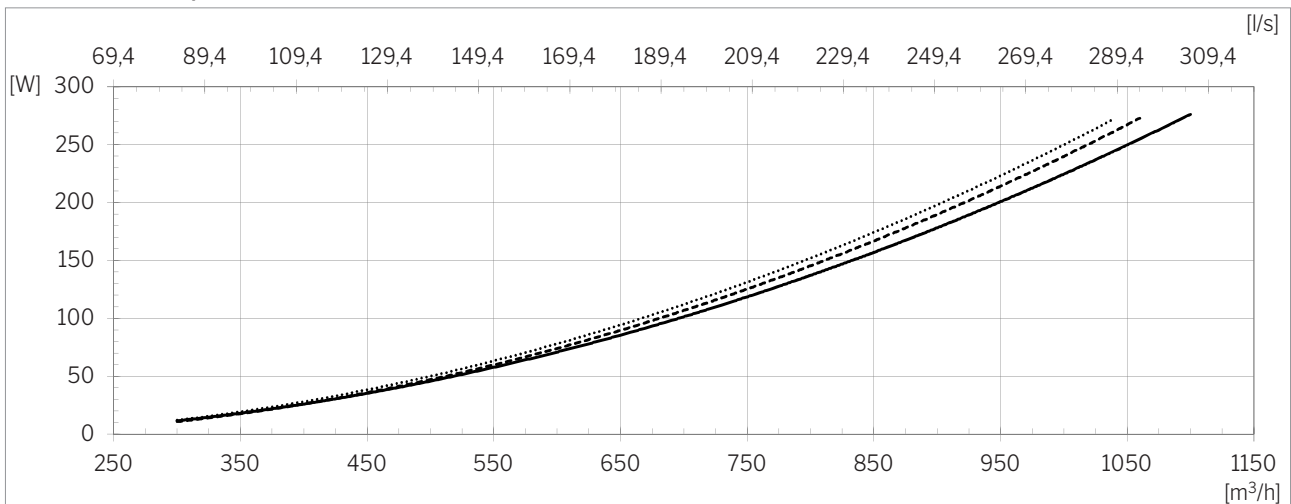

.....ePM₁ 80% / ePM₁₀ 50% - - - - ePM₁ 55% / ePM₁₀ 50% — ePM₁₀ 50% / ePM₁₀ 50%

⁹ All measurements were performed with an AM 1000 HH TT in normal operating mode in a standard installation, using the wall grilles Ø315 recommended by Airmaster with room attenuation of 9 dB.

Throw (0,2 m/s)¹⁰

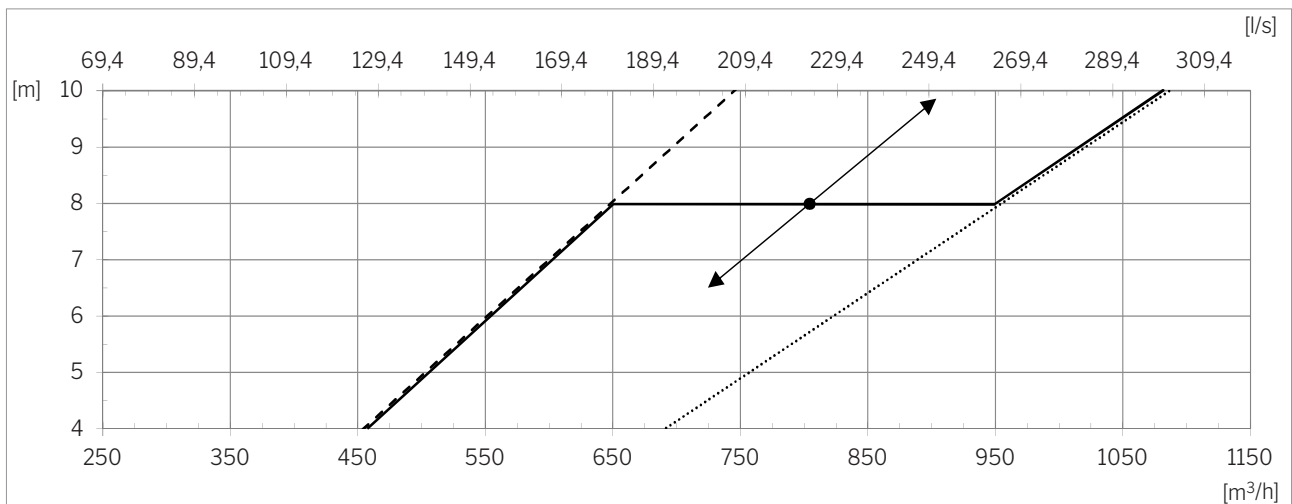

---- Tight inlet diffuser opening Wide inlet diffuser opening ● Setpoint throw length¹¹

Symmetrical air distribution^{12,13} with Adaptive Airflow™.

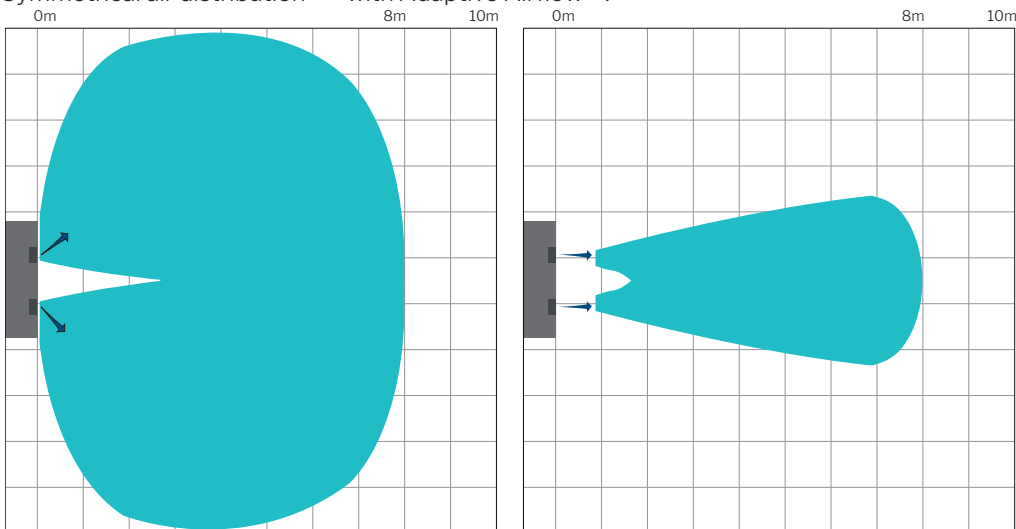

¹⁰ The throw is measured with 2°C subcooled supply air.

¹¹ Set point for throw length can be adjusted using a PC with "Airlinq® Service Tool" installed.

¹² Image on the left: Maximum airflow / inlet diffuser completely open.

¹³ Image on the right: Low airflow / inlet diffuser completely tightened.

Throw (0,2 m/s)¹⁴:

Asymmetrical air distribution^{15 16} with Adaptive Airflow™ and left facing inlet air grilles.

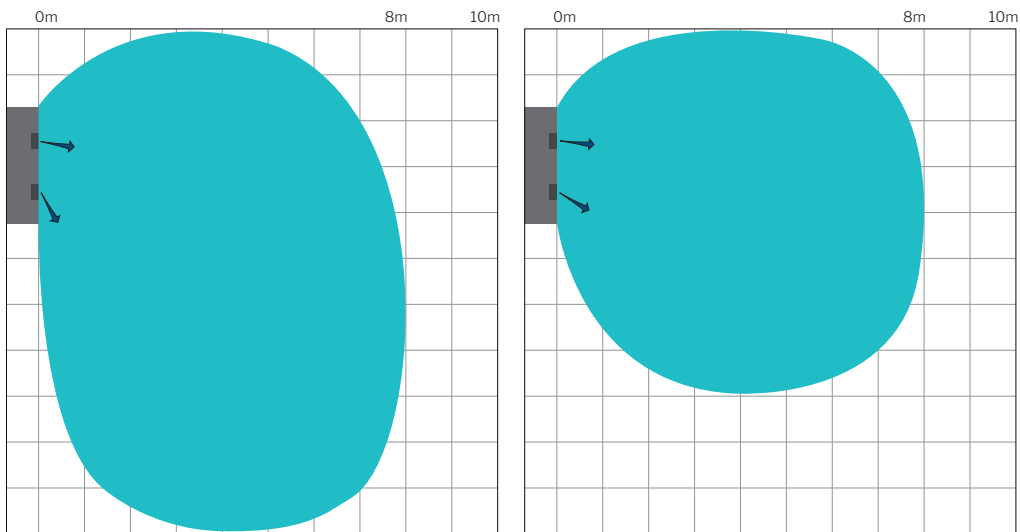

Asymmetrical air distribution^{15 16} with Adaptive Airflow™ and right facing inlet air grilles.

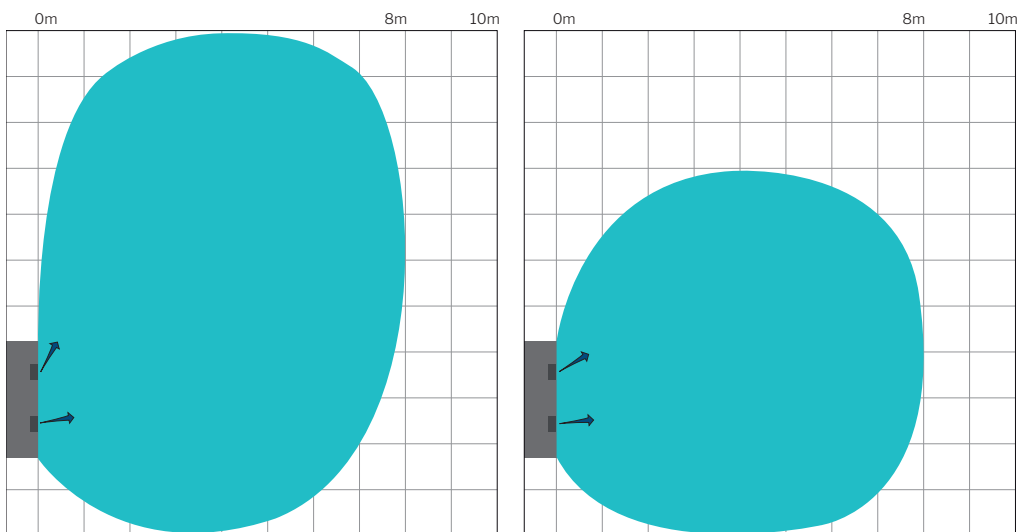

¹⁴ The throw is measured with 2°C subcooled inlet.

¹⁵ Image on the left: Maximum airflow / inlet diffuser completely open.

¹⁶ Image on the right: Low airflow / inlet diffuser completely tightened.

Version overview

Exhaust and supply position

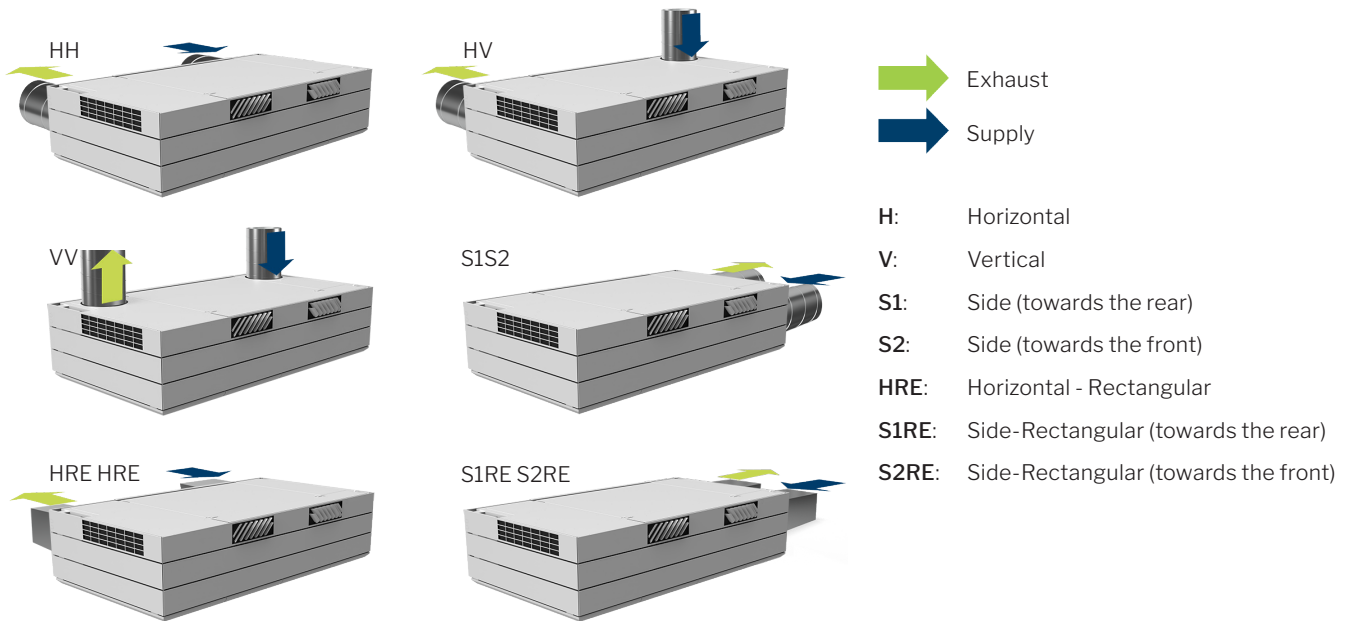

Inlet and extract position

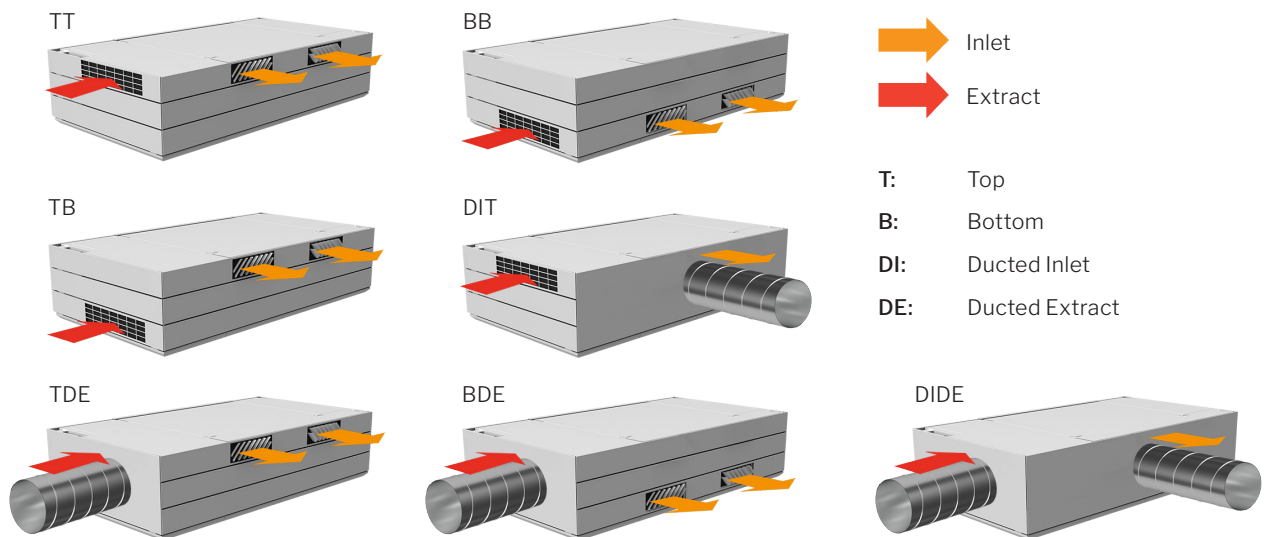

Standards and options

Counterflow heat exchanger (aluminum)	x
Enthalpy counterflow heat exchanger (polymer membrane)	o
Combination counterflow heat exchanger (polymer membrane)	o
Bypass damper	x
Supply damper (motor-controlled)	x
Exhaust damper (motor-controlled)	x
Capacitive return for motorized exhaust and supply air dampers	•
Adaptive Airflow™	•
Electric preheating surface	•
Electric comfort heating surface	•
Water comfort heating surface	•
Condensate pump	•
CO ₂ sensor (integrated)	•
TVOC (integrated)	•
CO ₂ -/TVOC sensor (integrated)	•
PIR/motion sensor (integrated)	•
CO ₂ sensor (wall mounted)	•

PIR/motion sensor (wall mounted)	•
Hygostat (wall mounted)	o
Energy meter single-phase or three-phase	•
Outdoor air filter ePM ₁₀ 50%	•
Outdoor air filter ePM ₁ 55%	•
Outdoor air filter ePM ₁ 80%	o
Extract air filter ePM ₁₀ 50%	x
Wall-/ceiling bracket	x
Control panel, Airlinq® Viva	•
Control panel, Airlinq® Orbit	•
Airmaster Airlinq® Online	•
Airmaster Airlinq® Online API	•
Airlinq® BMS	•
MODBUS® RTU RS485 module	•
BACnet™ MS/TP module	•
BACnet™ /IP module	•
LON® module	o
KNX® module	o

X : Standard • : Optional o : Special item (not stock item)

Schematic sketch

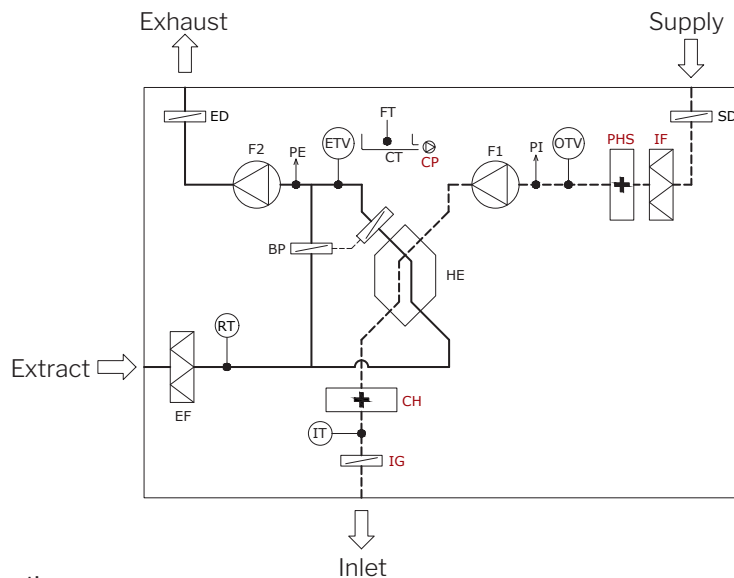

Component designation

BP	Bypass damper (motor-controlled)	ETV	Exhaust temperature sensor	DP2	Measuring tube, exhaust air fan
CH	Electrical comfort heating surface (option)	FT	Float	PE	Flow meter, extract air
CP	Condensate pump (option)	F1	Outdoor air fan	PHS	Electric preheating surface (option)
CT	Condensate tray	F2	Exhaust air fan	PI	Flow meter, supply air
ED	Exhaust damper (motor-controlled)	HE	Counterflow heat exchanger	RT	Room temperature sensor
EF	Extract air filter	IF	Outdoor air filter (option)	OD	Supply damper (motor-controlled)
		IG	Adaptive Airflow™ (option)		
		IT	Supply air temperature sensor		
		OTV	Outdoor air temperature sensor		