

The background features several large, overlapping, wavy lines composed of many thin, parallel lines, creating a sense of motion and depth. These lines are light gray and curve across the page, framing the central text.

# Installation

CONNECTIONS · COMMUNICATION · COMMISSIONING

AM 150 | AM 300 | AM 500 | AM 800 | AM 900 | AM 1000 | AM 1200

DV 1000

AIRMASTER

## SAFETY INSTRUCTIONS



This manual must be read before installing the Airmaster air handling unit. Following this manual will ensure this product is operated correctly.

The manufacturer cannot be held liable for damage arising from use or installing in contravention of these instructions.

The installation contractor is responsible for ensuring that the unit is installed according to current regulations and standards.

The manufacturer reserves the right to make changes without notice. All values stated are nominal values and can be affected by local conditions.

When installing the air handling unit in a room with a fire or stove drawing air from the room, all applicable provisions must be observed.

Failure to observe the warnings indicated by a danger symbol implies a risk of personal injury or damage to property.

The unit should not be used in rooms with abrasive particles or flammable or corrosive gas in the air, in wet rooms or explosion-protected rooms.

This manual relates to the Airmaster unit it accompanies plus all equipment, and must be given to and saved by the unit's owner.

The unit should not be used without the filters specified in the "Operation and Maintenance" manual.

All necessary data and guides to network integration can be downloaded from [www.airmaster-as.com](http://www.airmaster-as.com).

## WARNINGS



Service covers may not be opened without first disconnecting the unit's power supply and preventing use.



The unit may not be started up until all service covers and grates on duct connections have been installed.



The installer must wear personal protective safety equipment, such as safety shoes, during the installation of the unit

Place of installation and serial numbers (S/N):

Type: \_\_\_\_\_

Delivery date: \_\_\_\_\_

Place of installation: \_\_\_\_\_

S/N of Air handling unit: \_\_\_\_\_

S/N of Cooling Module: \_\_\_\_\_

# Table of Contents

<b>1. Condensate drain line</b>	<b>5</b>
1.1. Installation of the condenser drain line for air handling units supplied with a condensate pump	5
1.1.1. Optional installation of the condensate pump's draining hose outdoors	5
<b>2. Heating surfaces</b>	<b>6</b>
2.1. Water heating surface	6
2.1.1. Bleeding	6
2.1.2. Setting the line regulating valve	7
2.1.3. Frost protection valve	7
2.1.4. Setting the control valve	7
2.1.5. Check heating surface	8
2.2. Electric heating surfaces	8
<b>3. Electrical installation</b>	<b>9</b>
3.1. Supply voltage	9
3.2. Connection of electrical equipment	9
3.2.1. Data cable	10
3.2.2. Shield termination	10
3.2.3. Control panel	10
3.2.4. External start	10
3.2.5. External stop function	11
3.2.6. Boost	11
3.2.7. Analogue BMS	11
3.3. Checking electrical installation	12
<b>4. Airlinq BMS installation</b>	<b>13</b>
4.1. Connectors	13
4.2. DIP Switch / Jumper	13
4.3. Wiring-diagram for typical Airlinq BMS systems	13
4.4. Junction box for group control panels	13
4.5. System programming	14
4.5.1. Programming units ID1 to ID19	15
4.5.2. Programming ID0	16
4.5.3. Programming group control panels for groups 1 to 19	17
4.5.4. Programming cooling modules ID1 to ID19	18
<b>5. Commissioning and final inspection</b>	<b>19</b>
5.1. Commissioning	19
5.2. Final inspection	20

<b>Appendix 1</b>	<b>Wiring diagrams .....</b>	<b>21</b>
Control box.....		21
AQC-L (black control box) for AM 150, 300 and AM(L) 500, 800 .....		21
AQC-P (grey control box) for AM(P) 500, 800, 900 and 1200, AM(S) 1000 and DV 1000.....		21
AQC-C (black control box) for cooling modules .....		21
DIP Switch and Jumper.....		21
Standard connections AM 150 with AQC-L (black control box).....		22
Standard connections AM 300 with AQC-L (black control box).....		23
Standard connections AM 500 and 800 with AQC-L (black control box).....		24
Standard connections AM 500, 800 and 900 with AQC-P (grey control box).....		25
Standard connections AM 1000 with AQC-P (grey control box), single-phase connection.....		26
Standard connections AM 1000 and 1200 with AQC-P (grey control box) .....		27
Connecting the AM 1000 sections.....		29
Connecting the AM 1000 and RC 1000 sections.....		29
Connecting the AM 1000 sections with build-in smoke detector (option) .....		30
Connecting the AM 1200 sections .....		31
Standard connections DV 1000 with AQC-P (grey control box).....		32
Wiring diagrams for typical Airlinq BMS systems.....		33
Individual units, one system control panel.....		33
Individual units with cooling module, one system control panel.....		33
Individual units with cooling module and group control panels, one system control panel .....		34
Combined system.....		35
BMS connections.....		36
LON® .....		36
KNX® .....		36
BACnet™/IP .....		37
BACnet™ MS/TP.....		38
MODBUS® RTU RS485.....		39
Airmaster Airlinq® Online (Ethernet).....		40
<b>Appendix 2</b>	<b>Error descriptions .....</b>	<b>41</b>

Airmaster's AM series is delivered either with a black control box (AQC-L) or with a grey control box (AQC-P). The DV series is always delivered with a grey control box (ACQ-P).

AM units with AQC-L:

AM 150  
AM 300  
AM 500 (specific designation: AML 500)  
AM 800 (specific designation: AML 800)

AM units with AQC-P:

AM 500 (specific designation: AMP 500)  
AM 800 (specific designation: AMP 800)  
AM 900 (specific designation: AMP 900)  
AM 1000 (specific designation: AMS 1000)  
AM 1200 (specific designation: AMP 1200)

## 1. Condensate drain line

### 1.1. Installation of the condenser drain line for air handling units supplied with a condensate pump

We recommend connecting the (AHU) condensate drain line from a condensate pump to a waste-water pipe.

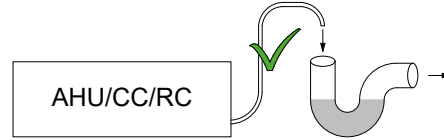

**We recommend installing a water trap into the waste-water system to block unpleasant odours emanating from the waste-water system.**

Dimension drawings of the condensate drain line are found in the installation instructions in the "Additional Dimensions" section.

#### 1.1.1. Optional installation of the condensate pump's draining hose outdoors

The condensate pump's draining hose can be led through the outer wall or over the roof.

If the condensate pump's draining hose must be led through the outer wall, drill a hole with a suitable diameter and an outwardly sloping gradient of 1-2%.

**Remember to seal the joint between the hose and outer wall or the hose and ceiling and roof.**

**THE HOSE MUST BE PROTECTED AGAINST FORMATION OF ICE.**

## 2. Heating surfaces

### 2.1. Water heating surface

The Airmaster air handling unit DV 1000 can be fitted with an external water heating surface. AM 300, 500, 800, 900, 1000 and 1200 can be fitted with an internal water heating surface.

The water heating surface for the DV 1000 is also used to protect against the formation of ice in the heat exchanger. The “Virtual Preheat” function is used for this purpose. Further details are available in the manual “Operation and Maintenance”.

For this solution, a motorised valve and an automatic heat retention thermostat are fitted on the heating surface. The water heating surface is leakage tested and final inspection performed according to standards and rules in effect.

The heating unit’s delivery flow is connected to the connection fitting marked FREM (“DELIVERY”) and the return flow to the connection fitting marked RETUR (“RETURN”).

**The dimensioning of pipes and valves and connection of water to the unit must always be carried out by an authorised specialist in accordance with current legislation and regulations.**

**There must be clean water in the installation for the internal valves in the water comfort heater to be able to function optimally without problems.**

It is recommended that shut-off valves, a dirt filter and a line regulating valve be fitted in accordance with the “External connection” block diagram. It is also recommended to mount the bleed valve and drain cock for commissioning and service.

It may be necessary (e.g. in the case of a district heating unit) to install a pressure differential regulator if the pressure difference  $\Delta p_s$  exceeds 40 kPa (10 kPa = 0,1 bar). If the differential pressure  $\Delta p$  rises above the internal construction above 40 kPa, the risk of noise from the control valve to the heating surface increases.

External connection (supplied by installation contractor)

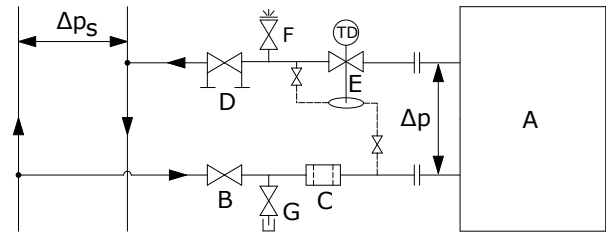

- A Internal assembly (supplied by Airmaster).
- B Shut-off valve.
- C Dirt filter.
- D Line regulating valve).
- E Pressure differential regulator.
- F Bleed valve.
- G Drain cock.

#### Internal construction:

In the case of DV 1000, the internal assembly is installed on the inside of the external heating surface. In the case of AM products, the unit must be opened for any connection work.

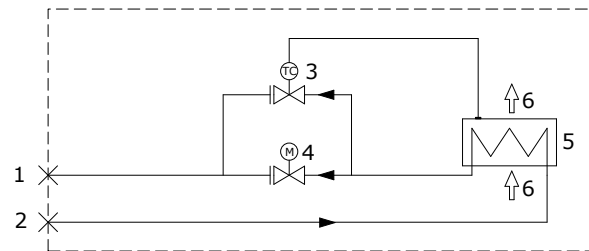

- 1 Return connection. (Delivery connection for the AM 800.)
- 2 Delivery connection. (Return connection for the AM 800.)
- 3 Frost protection valve (Comap D3803S) with remote temperature sensor (Comap Senso RI).
- 4 Control valve (Comap D3803S) with electric On/Off valve (Ballerex 43600012).
- 5 Water heating surface.
- 6 Airflow.

#### 2.1.1. Bleeding

Open the water throughflow and bleed the system using the bleed valve (F). After a short time any air noise in the water throughflow should cease.

**NB! The unit must be bled with fully open valves (3 + 4).**

### 2.1.2. Setting the line regulating valve

If a line regulating valve is installed, it must always be set in the interval between minimum flow and maximum flow.

- It is recommended to set the line regulation valve to a maximum flow according to the differential pressure of the heating system.
- The maximum flow is calculated using the largest known differential pressure in the system.
- The minimum flow is calculated using the smallest known differential pressure in the supply system.
- It is a prerequisite that the heat-bearing medium in the system is raw water, with an anti-corrosive agent added.

The following data applies to Airmaster's heating surfaces:

	Min. fluid flow at 0,3 m/s (l/h)	Max. fluid flow at 1,2 m/s (l/h)
AM 300	48	185
AM 500	75	300
AM 800	75	300
AM 900	120	480
AM 1000	135	540
AM 1200	120	480
DV 1000	340	1360

### 2.1.3. Frost protection valve

The sensor element on the frost protection valve is set to 8 °C (position in the middle between \* and 1) to ensure that the temperature according to the heating surface is kept above 8 °C, and that the water in the heating surface is free of frost. A prerequisite for this is that there is always hot water available with a sufficient differential pressure.

**NB! The heat supply or water flow must NEVER be cut off or switched off in freezing temperatures, nor when the air handling unit should be out of operation.**

**NB! The flow temperature must NEVER fall below 40°C during periods of frost.**

### 2.1.4. Setting the control valve

The heating surface's two valves are pre-set to 10 (completely open valve) when delivered. The freeze-protection valve must keep this setting unchanged.

The control valve must be set to a value based on a critical operation state. That is, the valve should not be limited to the nominal flow, but must at least have "Minimum flow" values available. When there is a high demand for heat, the heating surface can therefore supply more than the nominal values. On the other hand, cooling of the district heating water is reduced.

The following data applies to Airmaster's heating surfaces:

	Nominal flow (m³/h)	Min. fluid flow at 0,3 m/s (l/h)	Max. fluid flow at 1,2 m/s (l/h)
AM 300	275	48	185
AM 500	550	75	300
AM 800	725	75	300
AM 900	830	120	480
AM 1000	1100	135	540
AM 1200	1310	120	480
DV 1000	1000	340	1360

The valve can be set according to the calculations below and the graph so that the required flow can be achieved with the differential flow of Δps that is available.

**The system must be bled before it is adjusted.**

Parameters used in the calculation example:

OT	Lowest outside temperature (°C)
RT	Room temperature (°C)
n	Minimum efficiency of heat exchanger (%)
IT	Desired inlet temperature (°C)
V <sub>L</sub>	Inlet airflow (m³/h)
t <sub>F</sub>	Water temperature DELIVERY (°C)
t <sub>R</sub>	Water temperature RETURN (°C)
Δp	Desired differential pressure: 20-40 kPa, preferably around 30 kPa (10 kPa = 0.1 bar)

1. Calculate temperature (t) according to heat exchanger. [°C]

$$t = (RT - OT) * \frac{\eta}{100} + OT$$

2. Calculate heating requirement (Q) for heating the air to the desired inlet temperature. [W]

$$\dot{Q} = 0,34 * V_L * (IT - t)$$

3. Calculate the desired water quantity ( $\dot{V}_V$ ), [l/h]

$$\dot{V}_V = \frac{\dot{Q}}{1,163 * (t_F - t_R)}$$

4. Use the diagram to find the setting point for the control valve (4).

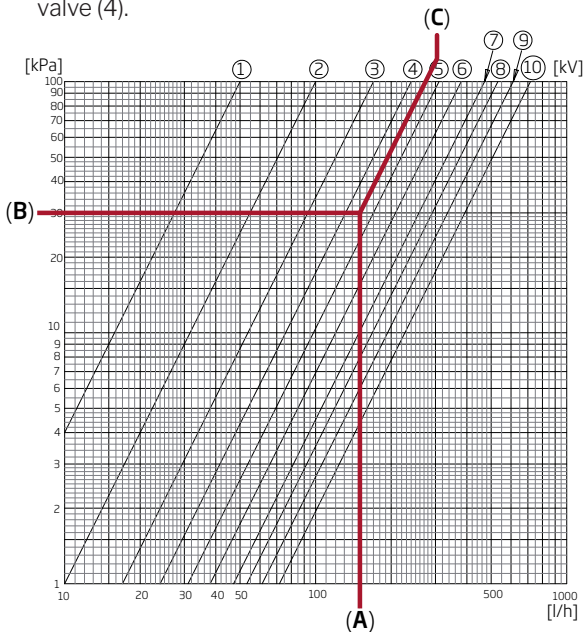

- Plot the calculated water quantity (A) on the diagram. (Here  $\dot{V}_V = 150$  l/h)
- Plot the desired differential pressure for the control valve (B) on the diagram. Here,  $\Delta p = 30$  kPa. (The optimal value for the valve is between 20 and 40 kPa)
- Use the diagonal lines to read off the value (C) for the valve setting.
- Set the valve to the calculated value using the presetting key. (In this example the control valve is set to 4,5)

Nominal flow and heat output apply to a winter state in which:

- The outdoor air is = -12 °C, 90% relative air humidity.
- The indoor air is = 22 °C, 20% relative air humidity.
- The heating supply's flow temperature is = 60 °C.

	Nominal flow (m <sup>3</sup> /h)	Nominal power (W)	Nominal fluid flow (l/h)
AM 300	275	1593	87
AM 500	550	858	53
AM 800	725	1379	60
AM 900	830	2345	111
AM 1000	1100	2540	112
AM 1200	1310	2454	107
DV 1000	1000	4099	180

### 2.1.5. Check heating surface

yes no

- Water pipes connected correctly to heating plant
- Heating surface is bled
- Heating surface is waterproof

- Frost protection valve adjusted to \_\_\_\_\_
- Control valve adjusted to \_\_\_\_\_
- Line regulating valve installed and adjusted to \_\_\_\_\_
- Pressure differential regulator installed and adjusted to \_\_\_\_\_

Name of installation engineer: \_\_\_\_\_

Comment: \_\_\_\_\_

### 2.2. Electric heating surfaces

Airmaster units can be supplied with one or two built-in electric heating surfaces. In such cases, the safety thermostats are installed inside the unit.

Electric heating surfaces for AM 150 and DV 1000 are installed as comfort heaters but are also used to protect against the formation of ice in the heat exchanger. The "Virtual Preheat" function is used for this purpose. See the manual "Operation and Maintenance".

**Electric heating surfaces consume more power. For further details please see datasheet.**

#### Safety functions on an electric heating surfaces:

The electric heating surfaces are protected against overheating by two safety thermostats for each heating surface, which disconnect the heating surfaces in the event of overheating.

The safety thermostats are installed in the heating surface.

- One of the thermostats disconnects the heating surface and is equipped with an automatic reset. For further details, see datasheet.
- The second thermostat also disconnects the heating surface but is equipped with a manual reset. For further details, see datasheet.





### 3. Electrical installation

**NB!** All electrical connections to the unit must be carried out by an authorised specialist in accordance with current legislation and regulations.

The length of all leads used in the installation must be adjusted to fit.

The power supply **MUST** be switched off for all connection work.

#### 3.1. Supply voltage

A pre-fuse and safety switch disconnecter must be fitted as part of the permanent installation for the unit in accordance with current legislation and regulations. Pre-fuse and safety switch disconnecter are supplied by the installation contractor.

The supply cable must be dimensioned in accordance with current rules and regulations, taking into account the conditions at the installation location.

The supply cable must be fixed to the cable tray to avoid it hanging loose in the unit.

Depending on the unit's power consumption and the existing electrical system, it may be necessary to set up at least one new power circuit.

When a number of units are installed, the permitted leakage current per unit must be taken into consideration. For further details, see datasheet.

The control panel, as well as any sensors, switches and optional items, must be fitted before the supply voltage is connected.

Electrical equipment must be connected in accordance with 'Appendix 1 Wiring Diagrams'.

The units must be connected to the power supply using a 3G0,75mm<sup>2</sup>, 3G1,5mm<sup>2</sup> or a 5G2,5mm<sup>2</sup> power supply cable.

#### 3.2. Connection of electrical equipment

Electrical equipment is connected at the control box:

- In the case of AM 150, 300, 500, 800 and 1000, under the base plate.
- In the case of AM 900, behind the front cover.
- In the case of AM 1200, under a service panel on the top of the unit's motor section.
- In the case of DV 1000, under the service panel on the side of the unit.

All connection work **MUST** be carried out with the power supply switched off in accordance with 'Appendix 3, Wiring Diagrams'.

##### AM 150, 300, 500 and 800 with AQC-L (black control box)

AQC-L control boxes contain a varistor that protects against overvoltage.

The AQC-L has 3 analogue inputs available. Inputs are programmed as standard:

- AI#1 (J17-5) for a movement sensor ("PIR"),
- AI#2 (J17-7) for overriding the flow by means of a CO<sub>2</sub> sensor ("CO<sub>2</sub> Sensor 1") and
- AI#3 (J17-11) for external start ("Ext start").

##### AM 500, 800, 900, 1000 and 1200 and DV 1000 with AQC-P (grey control box)

The AQC-P has 3 digital and 3 analogue inputs. Inputs are programmed as standard:

- DI#1 (J1-7) for a movement sensor ("PIR"),
- DI#2 (J1-6) for external start ("Ext start"),
- DI#3 (J1-5) for start via an A-BMS ("A-BMS Start"),
- AI#1 (J1-14) for flow control via A-BMS ("A-BMS Flow"),
- AI#2 (J1-13) for inlet temperature control via A-BMS ("A-BMS Temp") and
- AI#3 (J1-12) for overriding the flow by means of a CO<sub>2</sub> sensor ("CO<sub>2</sub> Sensor 1").

Inputs on all units can be programmed for other signal sources.

**Other settings in the control system software must be performed using a PC running the Airlinq Service Tool. The program can be downloaded from [www.airlinq.eu](http://www.airlinq.eu).**

### 3.2.1. Data cable

The connection cable for the control panel is a Shielded Twisted Pair (STP) 2x2x0.6 data cable. Larger STP data cables can also be used. Sensors can also be connected with a non-twisted pair but shielded data cable.

The following instructions apply when preparing the cable for the terminals in the panel/sensor:

- Strip the insulation from the sheathing and shielding as closely to the connection terminations as possible for reasons of EMC noise.
- When stripping the insulation, take care to ensure that the leads are not damaged and do not break.
- Maintain the twisted pairing of the leads right up to the terminals.

The following instructions apply when connecting the cable to the unit's optional plug:

- Strip the insulation as closely to the connection terminals as possible for reasons of EMC noise.
- When stripping the insulation, take care to ensure that the leads are not damaged and do not break.
- Maintain the twisted pairing of the leads right up to the terminals.
- Terminate the shield (see "Shield Termination").

Information on cables for D-BMS connections can be found in "Appendix 1 BMS connections".

Electrical equipment must be connected according to the wiring diagrams shown in "Appendix 1 Wiring Diagrams".

**The length of all leads used in the installation must be adjusted to fit.**

### 3.2.2. Shield termination

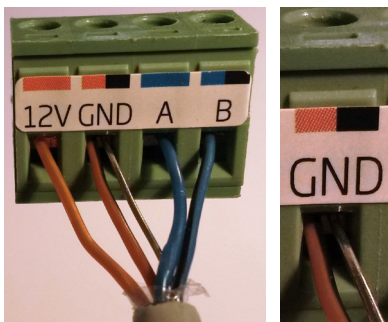

The following instructions apply to termination of the shield for both the control panel and all sensors next to the control box inside the air handling unit.

Connect drain wire to ground (GND), cut away shielding foil.

**The shield must be removed at the control panel and sensors. Do not over-tighten the screws.**

### 3.2.3. Control panel

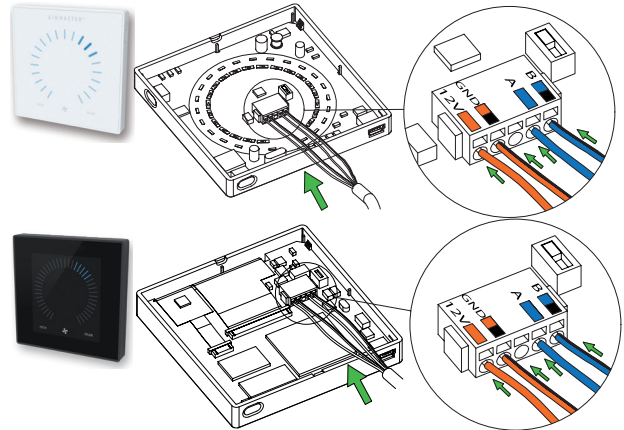

The delivery usually includes a control panel (loose) and a pre-fitted, 6,5-metre cable.

Mount the control panel at a suitable height on the wall, usually in the same room as the air handling unit. It may, however, be placed in an adjacent room.

To avoid problems during installation of the control panels, leave a minimum of 50 mm to the nearest obstacle.

**Leads for A/B and 12 V/GND must be twisted pair. The screen must be carefully removed to prevent short-circuiting.**

Electrical equipment must be connected according to the wiring diagrams shown in "Appendix 1 Wiring Diagrams".

### 3.2.4. External start

The unit is supplied with its own low voltage signal, e.g. via an external contact (e.g. a circuit breaker or a hygrostat). The unit starts when the contact closes. If the signal is disrupted, the unit will stop.

Electrical equipment must be connected according to the wiring diagrams shown in "Appendix 1 Wiring Diagrams".

### 3.2.5. External stop function

The “External Stop” function can shut down the unit independently of other start signals, e.g. in an emergency.

The unit is supplied with its own low voltage signal, e.g. by means of a smoke detector via a normally open (NO) relay for as long as the unit is in operation. The unit is started by the programmed start signals. If the function signal is disrupted (contact opens), the unit will stop immediately, regardless of status.

#### AM 150, 300, 500 and 800 with AQC-L (black control box)



Connect a 13.5 VDC signal, e.g. using a smoke detector via a NO relay (1) from terminal J17-1 to terminal J17-5 (AI#1), J17-7 (AI#2) or J17-11 (AI#3).

Input AI#1, AI#2 or AI#3 must be set to “External Stop” using a PC running the Airlinq Service Tool.

#### AM 500, 800, 900, 1000 and 1200, DV 1000 with AQC-P (grey control box)

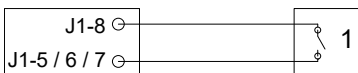

Connect a 12 VDC signal, e.g. using a smoke detector via a NO relay (1) from terminal J1-8 to terminal J1-5 (DI#3), J1-6 (DI#2) or J1-7 (DI#1).

Input DI#3, DI#2 or DI#1 must be set to “External Stop” using a PC running the Airlinq Service Tool.

### 3.2.6. Boost

The boost function can be used to adjust the airflow temporarily. The function is programmed with fixed control voltages for both the supply and the exhaust fan and, if applicable, with afterflow time. It is possible to adjust the control voltages for the fans independently of each other if unbalanced ventilation is required.

The unit is supplied with its own low voltage signal, e.g. via an external contact (e.g. a switch) (1). The air handling unit stops normal operation and activates the boost function when the contact closes. If the signal is disrupted, the unit will return to the previous operating mode. If the air handling unit has stopped, the boost function will start the unit.

#### AM 150, 300, 500 and 800 with AQC-L (black control box)

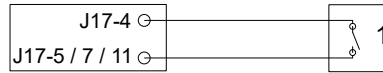

Connect a 13.5 VDC signal via an external NO contact (e.g. a switch) (1) from terminal J17-1 to terminal J17-5 (AI#1), J17-7 (AI#2) or J17-11 (AI#3).

Input AI#1, AI#2 or AI#3 must be set to “Boost” using a PC running the Airlinq Service Tool. The control voltages and, if applicable, after run time for the function must be programmed.

#### AM 500, 800, 900, 1000 and 1200, DV 1000 with AQC-P (grey control box)

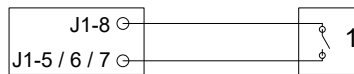

Connect a 12 VDC output signal from terminal J1-8 via an external contact (NO) (e.g. a switch) (1) to terminal J1-5 (DI#3), J1-6 (DI#2) or J1-7 (DI#1).

Input DI#1, DI#2 or DI#3 must be set to “Boost” using a PC running the Airlinq Service Tool. The control voltages and, if applicable, after run time for the function must be programmed.

### 3.2.7. Analogue BMS

An Airmaster air handling unit can be connected to an **A**nalogue **B**uilding **M**anagement **S**ystem (A-BMS).

#### AM 150, 300, 500 and 800 with AQC-L (black control box)

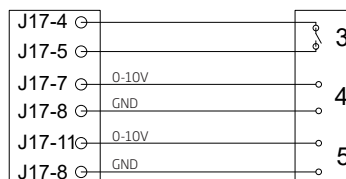

The BMS system passes the 13.5 VDC output signal via contact (NO) (3) from terminal J17-4 on terminal J17-5 (AI#1). Consequently, the ventilation unit will start and stop according to the BMS system’s programming.

The airflow volume (4) and inlet temperature (5) are controlled by a potential-free 0-10 volt signal on terminal J17-7 (AI#2), on terminal J17-11 (AI#3) and GND on terminal j17-8 of the A-BMS (4, 5).

Input AI#1 must be set to “A-BMS Start”, input AI#2 to “A-BMS Flow” and input AI#3 to “A-BMS Temp” using a PC running the Airlinq Service Tool.

If you simply wish to stop or start the unit using A-BMS, and otherwise let it assume the airflow volume and inlet temperature set on the control panel or set by, e.g. a CO2 sensor, the start signal only should be connected to “Ext start”.

Electrical equipment must be connected according to the wiring diagrams shown in “Appendix 1 Wiring Diagrams”.

**AM 500, 800, 900, 1000 and 1200, DV 1000 with AQC-P (grey control box)**

For all Airmaster air handling units with AQC-P, the A-BMS connection is programmed ex works. Electrical equipment must be connected according to the wiring diagrams shown in “Appendix 1 Wiring Diagrams”.

### 3.3. Checking electrical installation

	yes	no
Control panel installed	<input type="checkbox"/>	<input type="checkbox"/>
PIR sensor installed	<input type="checkbox"/>	<input type="checkbox"/>
CO <sub>2</sub> sensor installed	<input type="checkbox"/>	<input type="checkbox"/>
External stop installed	<input type="checkbox"/>	<input type="checkbox"/>
External start installed	<input type="checkbox"/>	<input type="checkbox"/>
Boost installed	<input type="checkbox"/>	<input type="checkbox"/>
A-BMS installed	<input type="checkbox"/>	<input type="checkbox"/>
Power supply installed	<input type="checkbox"/>	<input type="checkbox"/>
Inputs programmed	<input type="checkbox"/>	<input type="checkbox"/>

Name of installation engineer:

Comment:

## 4. Airlinq BMS installation

The Airlinq BMS (Master/Slave) installation allows up to 20 Airmaster air handling units (Unit) and 20 cooling modules (CC Unit) to be controlled from one system control panel and up to 19 group control panels.

Please note that all units must have an identical software version. If units purchased at different times are connected together the software will most probably have to be updated in all units. Contact the manufacturer with regard to this.

Connect the units (control panel, units and cooling modules) as shown on the diagram. Maximum system cable length is 1000 m.

Use a shielded twisted pair (STP 2x2x0.6) data cable from the control panel to the unit and a shielded twisted pair data cable (STP 2x0.6) from unit to unit! The shield at each cable must only be connected at one end!

If over 100 m of data cable needs to be installed on a control panel, please contact Airmaster before connecting the cable.

The first and last unit must be terminated in a DIP Switch (control panel) or a jumper (control box). None of the other units may be terminated. The control panel can be connected as the first or last unit in the chain.

The system is programmed using a PC running the Airlinq Service Tool.

System:

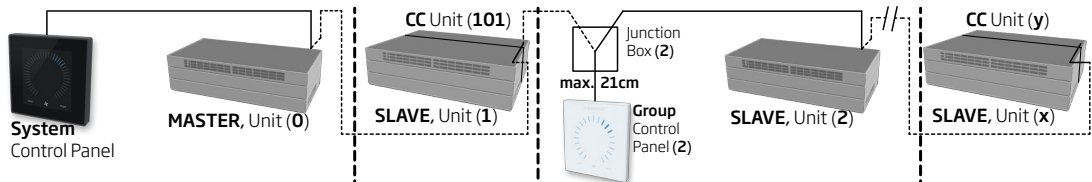

Wiring Diagram Data Cable:

RS485 bus system

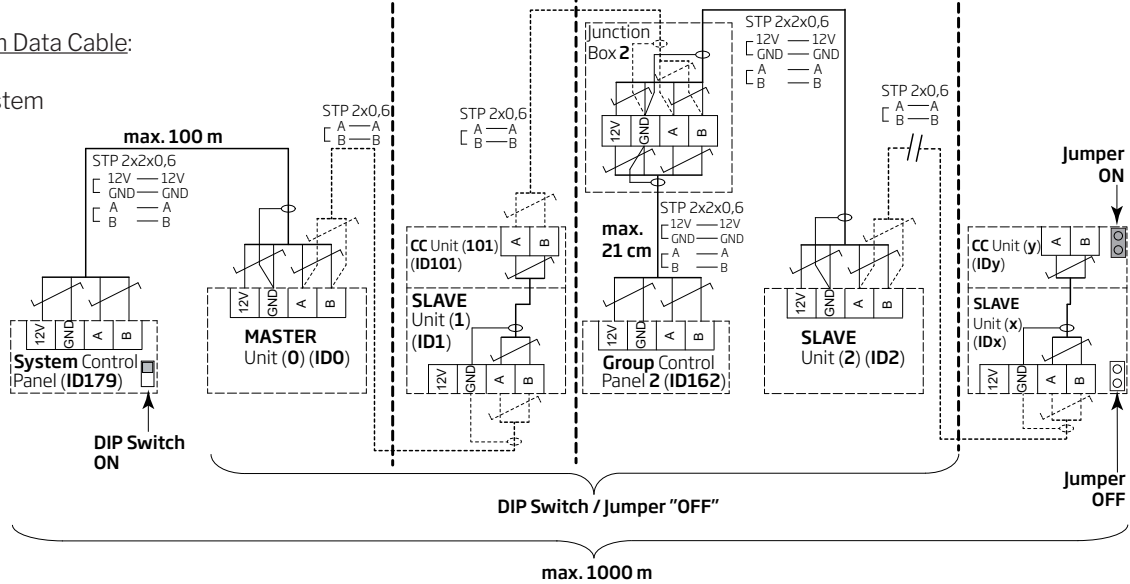

### 4.1. Connectors

See "Appendix 1 Wiring Diagrams".

### 4.2. DIP Switch / Jumper

See "Appendix 1 Wiring Diagrams".

### 4.3. Wiring-diagram for typical Airlinq BMS systems

See "Appendix 1 Wiring Diagrams".

### 4.4. Junction box for group control panels

The junction box must be installed in the immediate vicinity of the control panel. Cables longer than 21 cm are not permitted and may lead to communication errors.

## 4.5. System programming

*All programming is carried out using the Airlinq Service Tool program that is running on the unit to be programmed, i.e. on the unit's control box or cooling module, or on the control panel.*

Units in an Airlinq BMS system must be grouped in the building, according to the customer's requirements. This physical grouping is programmed in **the master** (system 0, unit 0, **ID0**) using a PC running the Airlinq Service Tool program. A group could, for example, be room 102 with unit 2 (unit 2, ID2) and unit 3 (unit 3, ID3). In each group, one unit is programmed to be the unit that determines the group's operations (Group Master).

All units must be programmed with the group identity (group ID) to which the unit in question must belong as well as their own identity (Communication ID). A cooling module must be paired with the unit on which the cooling module is installed. The cooling module's identity must be programmed. Further details are available in the programming instructions below and in the pairing table to the right.

Pairing of units with cooling modules:

Unit identity (Communication ID)	Cooling module identity (Communication ID)
ID0	ID100
ID1	ID101
ID2	ID102
...	...
ID18	ID118
ID19	ID119

An Airlinq Viva control panel, which is used as a group control panel, must be programmed with its allocation to a specific group (Group ID) and its own identity (Communication ID). Further details are available in the programming instructions below and in the pairing table to the right.

Pairing of Airlinq Viva with groups:

Group identity (Group ID)	Viva identity (Communication ID)
G0	ID160
G1	ID161
G2	ID162
...	...
G17	ID177
G18	ID178

***The maximum number of group control panels per system is 19. A system must always be supplied with an Airlinq Orbit control panel as the system control panel.***

The Airlinq Orbit control panel is programmed with the following identity ex works: ID179 (Communication ID). This setting should not be changed.

When all programming has been completed, the entire system can be put into operation. Further details are available under "Commissioning and final inspection".

#### 4.5.1. Programming units ID1 to ID19

Begin with the unit that will be given the designation ID1.

1. Switch off the unit's power supply.
2. Open the unit and connect a USB to mini B USB cable to the mini B USB port on the control box.
3. Switch on the power supply to the unit. Wait for 30 seconds.
4. Connect the USB to mini B USB cable to the PC. Start the Airlinq Service Tool.
5. Press "Connect". The "Please select your device" window opens.
6. Select "Direct Mode" and press "Enter" on the keyboard of the PC.

The program establishes communication with the control box. The "Please select your device" window closes.

7. Select "BMS" - "Airlinq" - "Group ID = 0" and press "Enter". The "Set new value" window opens.
8. Enter the group number you wish to allocate to the unit, e.g. "1".
9. Press "Enter". The "Set new value" window closes.

10. Select "BMS" - "Airlinq" - "Communication ID = 0" and press "Enter". The "Set new value" window opens.
11. Enter "1" for ID1.

12. Press "Enter". The "Reboot required" window opens.
13. Press "Enter". The control box will restart. The "Reboot required" window closes.
14. Wait for 60 seconds.
15. Switch off the power supply to the unit.
16. Remove the USB to mini B USB cable from the control box.
17. Close the unit.
18. Switch on the power supply to the unit.

Repeat the procedure for the rest of the units (ID2, ID3, ID4, ... ID19) in numerical order.

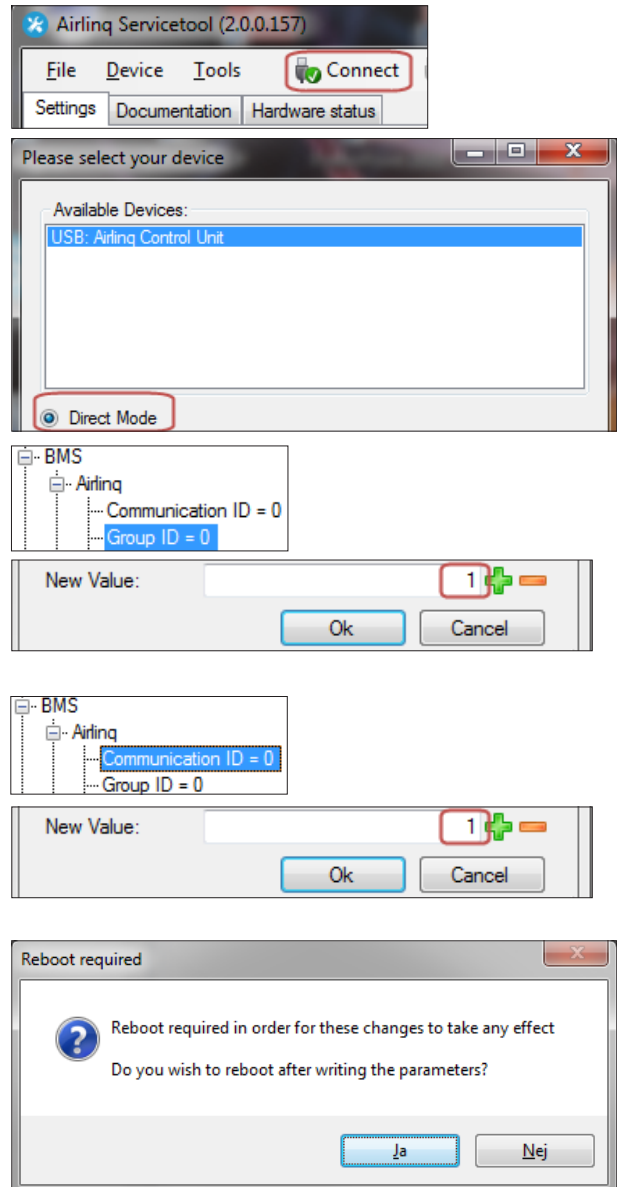

## 4.5.2. Programming ID0

1. Disconnect the power supply from the unit.
2. Open the unit and connect a USB to mini B USB cable to the mini B USB port on the control box.
3. Switch on the power supply to the unit. Wait for 30 seconds.
4. Connect the USB to mini B USB cable to the PC. Start the Airlinq Service Tool.
5. Press "Connect". The "Please select your device" window opens.
6. Select "Direct Mode" and press "Enter" on the keyboard of the PC.

The program establishes communication with the ID0 control box. The "Please select your device" window closes.

7. Select "BMS" - "Airlinq" - "Air Handling Units = 1" and press "Enter". The "Set new value" window opens.
8. Enter the number of air handling units in the system, e.g. "12" for a total of 12 units.
9. Press "Enter". The "Set new value" window closes.

10. Select "BMS" - "Airlinq" - "Group 1 Master = 0" and press "Enter". The "Set new value" window opens.
11. Enter the identity ("communication ID") of the unit that determines operations in, e.g., group "1" and, consequently, must be programmed as "Group Master", e.g. "1" for ID1.

(Group Master in group 0 is usually ID0; "Group 0 Master = 0")

12. Press "Enter". The "Set new value" window closes.  
(All units belonging to Group 1 will now be controlled by ID1.)

Repeat steps 10 to 12 for all groups to be programmed in the system ("Group 0 Master = 0", "Group 1 Master = 0", "Group 2 Master = 0", ... "Group 19 Master = 0") until all necessary "Group Masters" have been programmed.

13. Switch off the power supply to the unit.
14. Remove the USB to mini B USB cable from the control box.
15. Close the unit.
16. Switch on the power supply to the unit.

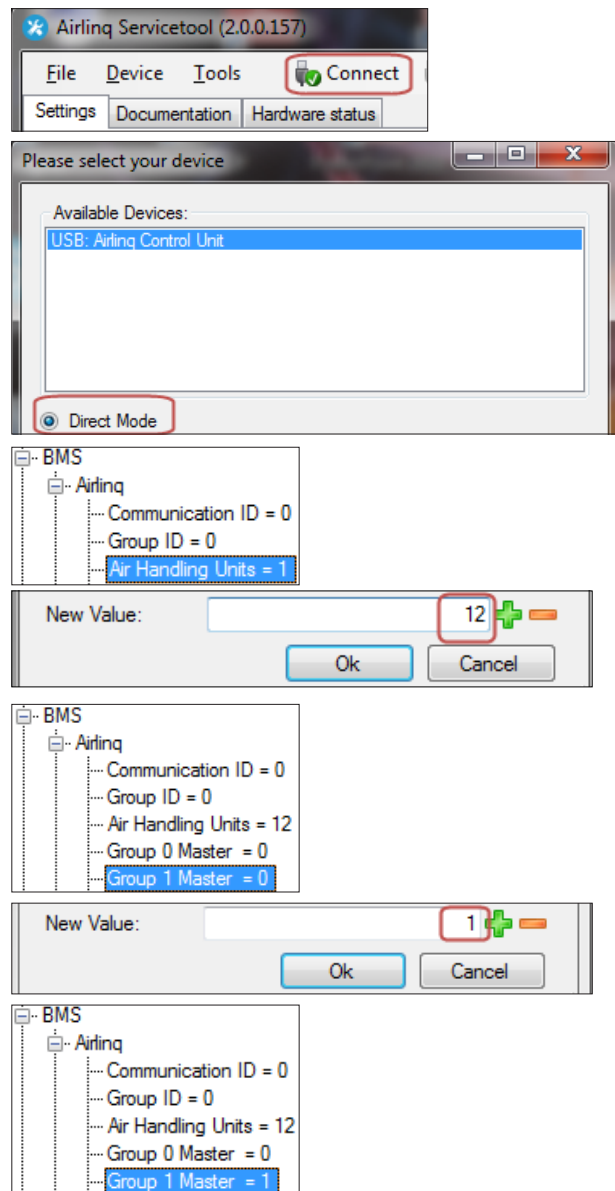



### 4.5.3. Programming group control panels for groups 1 to 19

Begin with group 1.

1. Connect a USB to mini B USB cable to the control panel's mini B USB port. Start the Airlinq Service Tool.
2. Press "Connect". The "Please select your device" window opens.
3. Select "Direct Mode" and press "Enter" on the keyboard of the PC.

The program establishes communication with the control panel. The "Please select your device" window closes.

4. Select "Group Settings" - "Group ID = 0" and press "Enter". The "Set new value" window opens.
5. Enter the group number to which you wish to connect the control panel, e.g. "1" for group 1.
6. Press "Enter". The "Set new value" window closes.

7. Select "Group Settings" - "Communication ID = 160" and press "Enter". The "Set new value" window opens.
8. Enter "161" for ID161.

*The control panel's identity is dependent on the identity of the group to which the control panel is connected. Further details are available in the 'System programming' section.*

9. Press "Enter". The "Reboot required" window opens.
10. Press "Enter". The control panel restarts. The "Reboot required" window closes.
11. Remove the USB to mini B USB cable from the control panel.

Repeat the procedure for the rest of the group control panels (ID162, ID163, ID164, ... ID178).

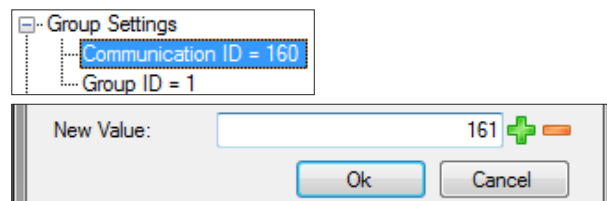
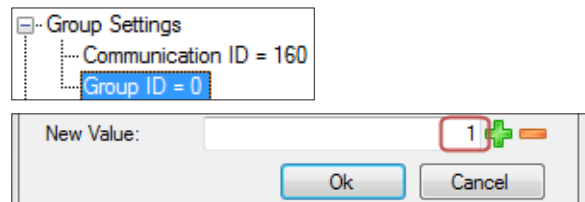
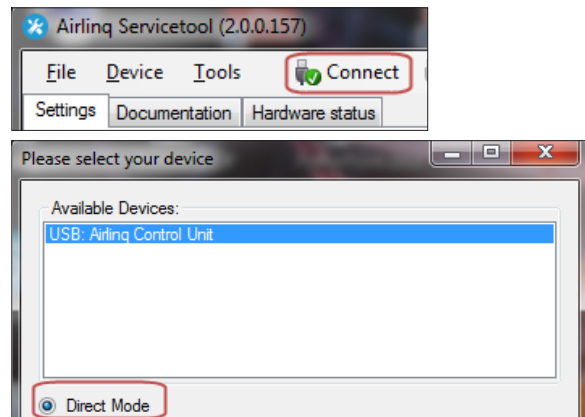

Pairing of Airlinq Viva with groups:

Group identity (Group ID)	Viva identity (Communication ID)
G0	ID160
G1	ID161
G2	ID162
...	...
G17	ID177
G18	ID178

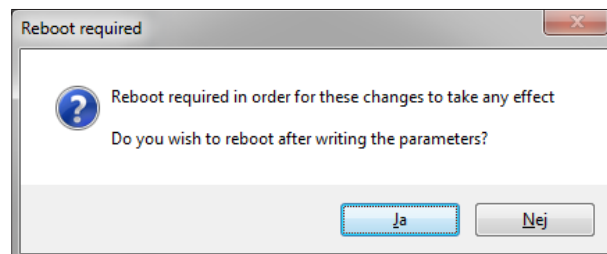

#### 4.5.4. Programming cooling modules ID1 to ID19

*A cooling module installed on the unit with communication identity 'ID0' does not need to be programmed.*

1. Disconnect the power supply to the air handling unit and the cooling module.
2. Open the cooling module and connect a USB to mini B USB cable to the mini B USB port on the control box.
3. Switch on the power supply to the unit. Wait for 30 seconds.
4. Connect the USB to mini B USB cable to the PC. Start the Airlinq Service Tool.
5. Press "Connect". The "Please select your device" window opens.
6. Select "Direct Mode" and press "Enter" on the keyboard of the PC.

The program establishes communication with the control box from the cooling module. The "Please select your device" window closes.

7. Select "Settings" - "Communication ID=100" and press "Enter". The "Set new value" window opens.
8. Enter the cooling module's identity, e.g. "101" for ID101.

*The cooling module's identity is dependent on the identity of the unit installed together with the cooling module. Further details are available in the 'System programming' section.*

9. Press "Enter". The "Reboot required" window opens.
10. Press "Enter". The control box restarts. The "Reboot required" window closes.
11. Remove the USB to mini B USB cable from the PC.
12. Wait for 60 seconds.
13. Disconnect the power supply to the unit and the cooling module.
14. Remove the USB to mini B USB cable from the control box.
15. Close the cooling module.
16. Switch on the power supply to the unit and the cooling module.

Repeat the procedure for the rest of the cooling modules (ID102, ID103, ID104, ... ID119).

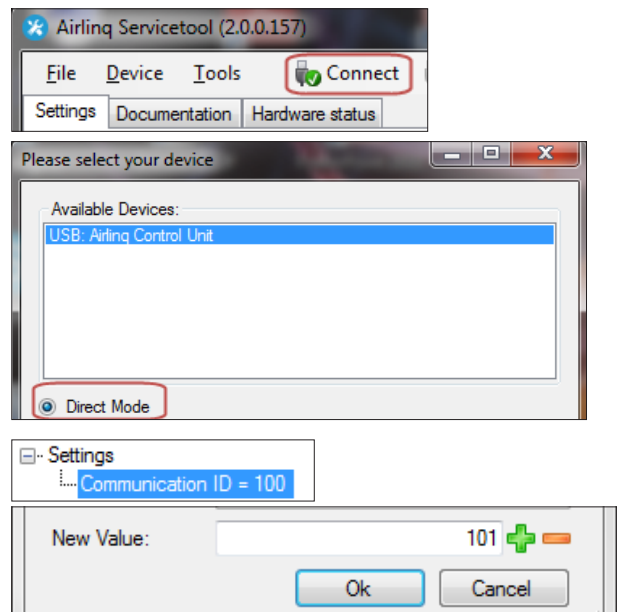

Pairing of units with cooling modules:

Unit identity (Communication ID)	Cooling module identity (Communication ID)
ID0	ID100
ID1	ID101
ID2	ID102
...	...
ID18	ID118
ID19	ID119

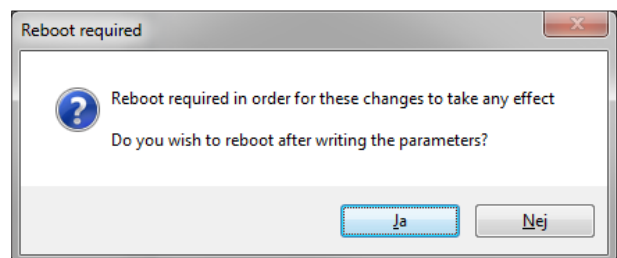

## 5. Commissioning and final inspection

Once installation of the Airmaster unit is complete, the basic operating functions must be checked. Once this has been done, all parameters and the unit's equipment must be programmed in accordance with the customer's operational requirements.

*Initial adjustments must be made to the ducting systems of units before they are started up.*

*In the case of Airlinq BMS systems, general settings can be made for the whole system or for whole groups. However, unit-specific settings must be set on each unit individually, using the Airlinq Service Tool.*

*During startup of AM1000, it is important that structural noise and vibration is not present (i.e. using drills or hammers on surrounding walls and ceiling), when the power supply is switched on. The calibration of the active noise cancelling (ANC) system during startup may fail if excessive structural noise is present.*

*A CO<sub>2</sub>/TVOC sensor calibrates itself during the first three weeks. During this period, the plant should preferably be in operation without power outages. In the beginning, the measurement may deviate from the actual CO<sub>2</sub>/TVOC level.*

### 5.1. Commissioning

- Close the unit and the cooling module if they are open.
- Ask the customer about requirements for unit operation.
- Switch on the power supply to the unit.
- Only units with Airlinq Viva (white control panel):
  - Connect a PC running the Airlinq User Tool to the mini B USB port at the bottom of the control panel.
  - Start the Airlinq User Tool.
  - The “Startup Guide” starts automatically. Or start the “Startup Guide” from the “Settings - Startup Guide” menu item in the program. Further details are available on page 20 of the “Operation and Maintenance” manual supplied with the unit. Follow all instructions in the Startup Guide closely, finishing with start up of the unit.
- Only units with Airlinq Orbit (black control panel):
  - The control panel's “Startup Guide” will start automatically when the unit is started for the first time. Otherwise, it can be activated manually from the “Settings - Startup Guide” menu item. Further details are available on page 20 of the “Operation and Maintenance” manual supplied with the unit.

Follow all instructions in the Startup Guide closely, finishing with start up of the unit.

- Check that extract air and supply air draw and blow, respectively.
- Perform other settings using a PC running the Airlinq Service Tool. Enter all data required by the “Operation and Maintenance” manual and the instructions in the program.
- All units (AM 500, 800, 900, 1000, 1200 and DV 1000) with AQC-P (grey control box):
  - Connect a PC running the Airlinq Service Tool to the mini B USB port at the bottom of the control panel and start the program.
  - Press “Connect”.

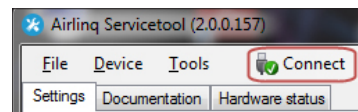

- Select the unit's communication ID under “Address Mode” - “Device Address”, e.g. “0” for “ID0” or “1” for “ID1”.

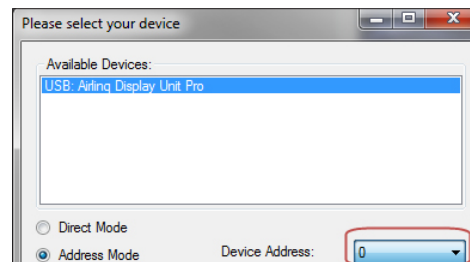

- Perform filter calibration from “Settings” - “Process Settings” - “Filter” - “Settings”.

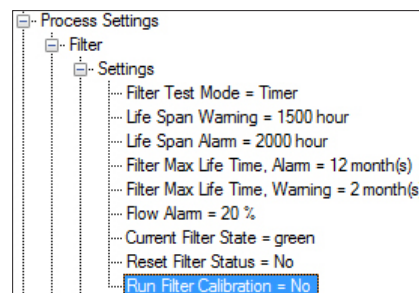

- Highlight the “Run filter calibration” parameter and press “Enter” on the keyboard. The “Set new value” window opens.

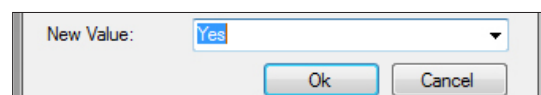

- Set “Yes” and press “Enter” on the keyboard. The “Set new value” window closes.

**Filter calibration must be performed for each individual unit in an Airlinq BMS system.**

If filter calibration is not performed when the unit is started up, it will be performed automatically after 25 hours of operation.

- Once the settings have been made according to the customer's requirements, stop the unit temporarily.
- Restart the unit.
- Check the inlet flow pattern in the room at max. airflow. Adjust the inlet flow pattern according to the guide in the "Operation and Maintenance" manual if necessary.
- Only AM 1000:
  - The setting of Adaptive Airflow™ with automatic throw length adjustment is carried out using a PC with the program, Airlinq Service Tool under "Settings" - "Operation" - "Room Details" - "Adaptive Airflow Throw Setpoint"..

## 5.2. Final inspection

yes no

The unit starts correctly

All parameters are programmed

Installation engineer's name:

NB:

- Optionally complete the "Performance Test" using a PC running the program "Airlinq Service Tool".
- Remove labels/protective cardboard from the base plate.
- Inform the customer that installation is complete.
- Hand over all manuals to the customer.

# Appendix 1 Wiring diagrams

## Control box

### AQC-L (black control box) for AM 150, 300 and AM(L) 500, 800

Connection of databus RS485 (J16) and signal sources (J17):

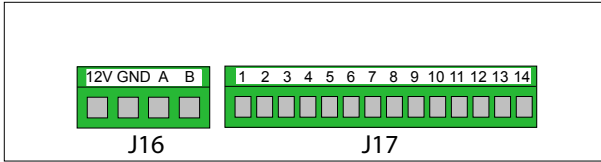

Connection of digital BMS/Ethernet (J18) and PC communication (J19); jumper setting:

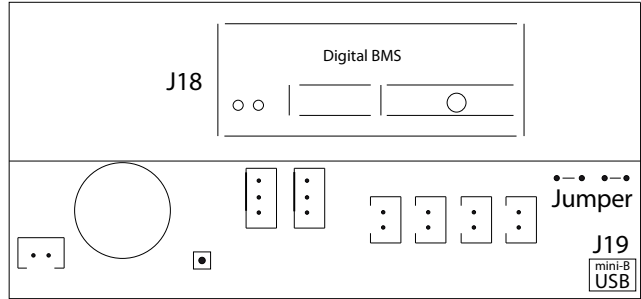

### AQC-P (grey control box) for AM(P) 500, 800, 900 and 1200, AM(S) 1000 and DV 1000

Connection of digital BMS/Ethernet (J5), signal sources (J1), databus RS485 (J3) and PC communication (J4):

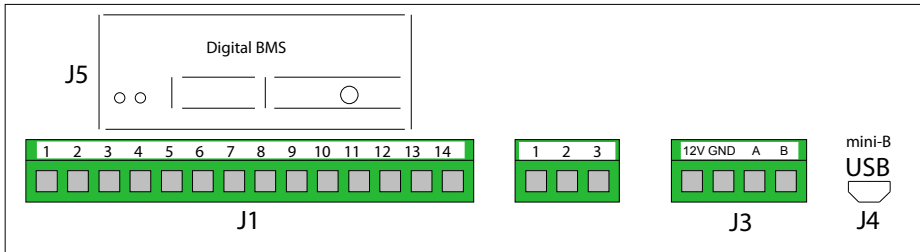

The jumper is set inside the control box.

### AQC-C (black control box) for cooling modules

Connection of PC communication (J15), jumper setting:

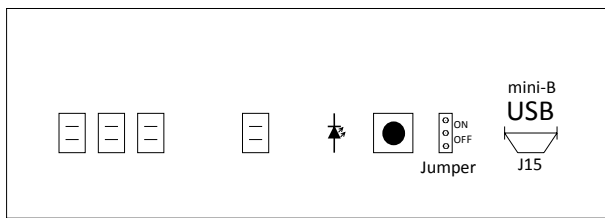

Connection of databus RS485 (J6):

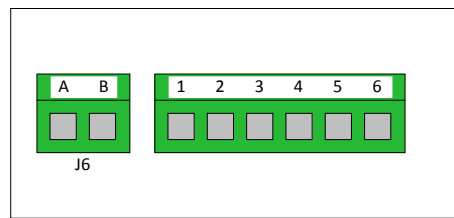

### DIP Switch and Jumper

DIP Switch next to a control panel.

Closed ("ON", standard):

Open ("OFF"):

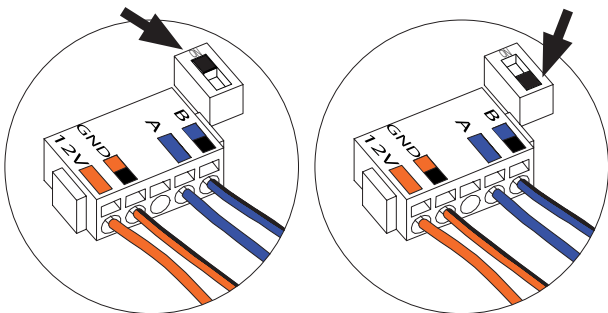

A jumper in a control box is open as standard ("OFF").

AQC-P and AQC-C:

OFF:

ON:

AQC-L:

OFF:

ON:

Standard connections AM 150 with AQC-L (black control box)

BK: Black  
 BN: Brown  
 BU: Blue  
 GN: Green  
 OR: Orange  
 YE: Yellow

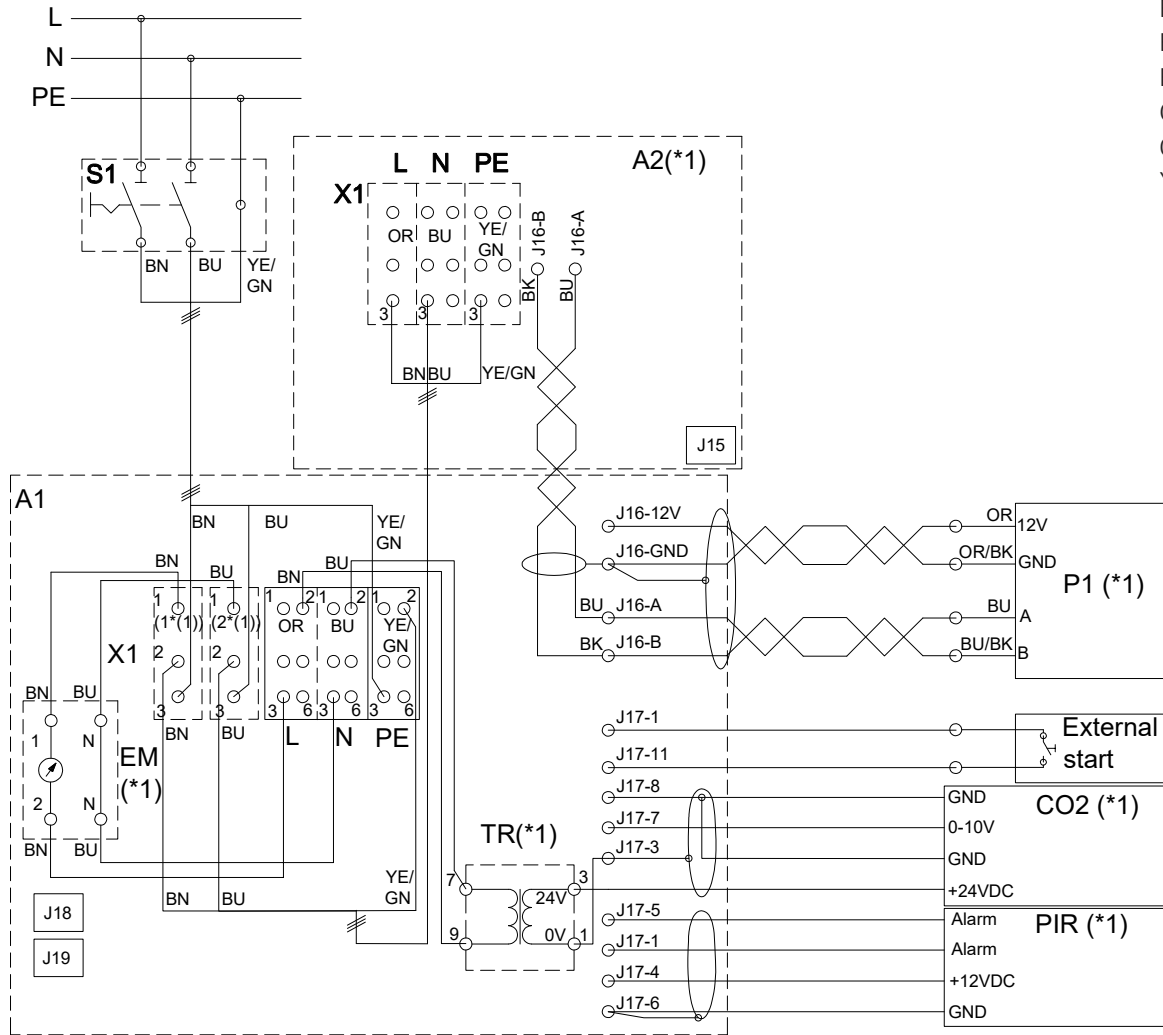

- |         |   |         |   |
|---------|---|---------|---|
| J6      | Plug, RS485   | J18     | BMS plug (LON®, KNX®, MODBUS®, BACnet™), Ethernet                             |
| J6-A    | + RS485 (A)   |         |   |
| J6-B    | - RS485 (B)   | J15/J19 | Mini-B USB plug (PC connection)   |
| J16     | Plug, control panel   | (*1)    | Option  |
| J16-12V | 12 VDC output   | (*2)    | If no energy meter, connect the power supply cable to X1-L(3), N(3) and PE(3) |
| J16-GND | GND   | A1      | Air handling unit   |
| J16-A   | + RS485 (A)   | A2      | Cooling module (*1)   |
| J16-B   | - RS485 (B)   | B1      | PIR/motion sensor (wall mounted) (*1)   |
| J17     | Plug, option connection   | B2      | CO <sub>2</sub> sensor (wall mounted) (*1)                                    |
| J17-1   | 13.5 VDC output   | EM      | Energy meter (*1)   |
| J17-3   | GND   | P1      | Control panel (*1)  |
| J17-4   | 13.5 VDC output   | S1      | Supply separator (not supplied by Airmaster)                                  |
| J17-5   | PIR (AI#1) or External Stop/analogue BMS Start (input 0-10VDC or 13,5VDC)   | TR      | Power supply 24 Volt DC (*1)  |
| J17-6   | GND   | X1      | Terminal clamps, power supply   |
| J17-7   | 0-10 Volt CO <sub>2</sub> signal (AI#2) or analogue BMS flow or analogue BMS temperature/External Stop (input 0-10VDC or 13,5VDC) |         |   |
| J17-8   | GND   |         |   |
| J17-11  | External start (AI#3) or External Stop/analogue BMS Start (input 0-10VDC or 13,5VDC)  |         |   |
| J17-12  | GND   |         |   |
- External Stop, Boost, analogue BMS start - see section "Connection of electrical equipment".
- All digital and analogue inputs can be programmed using the "Airlinq Service Tool".**

## Standard connections AM 300 with AQC-L (black control box)

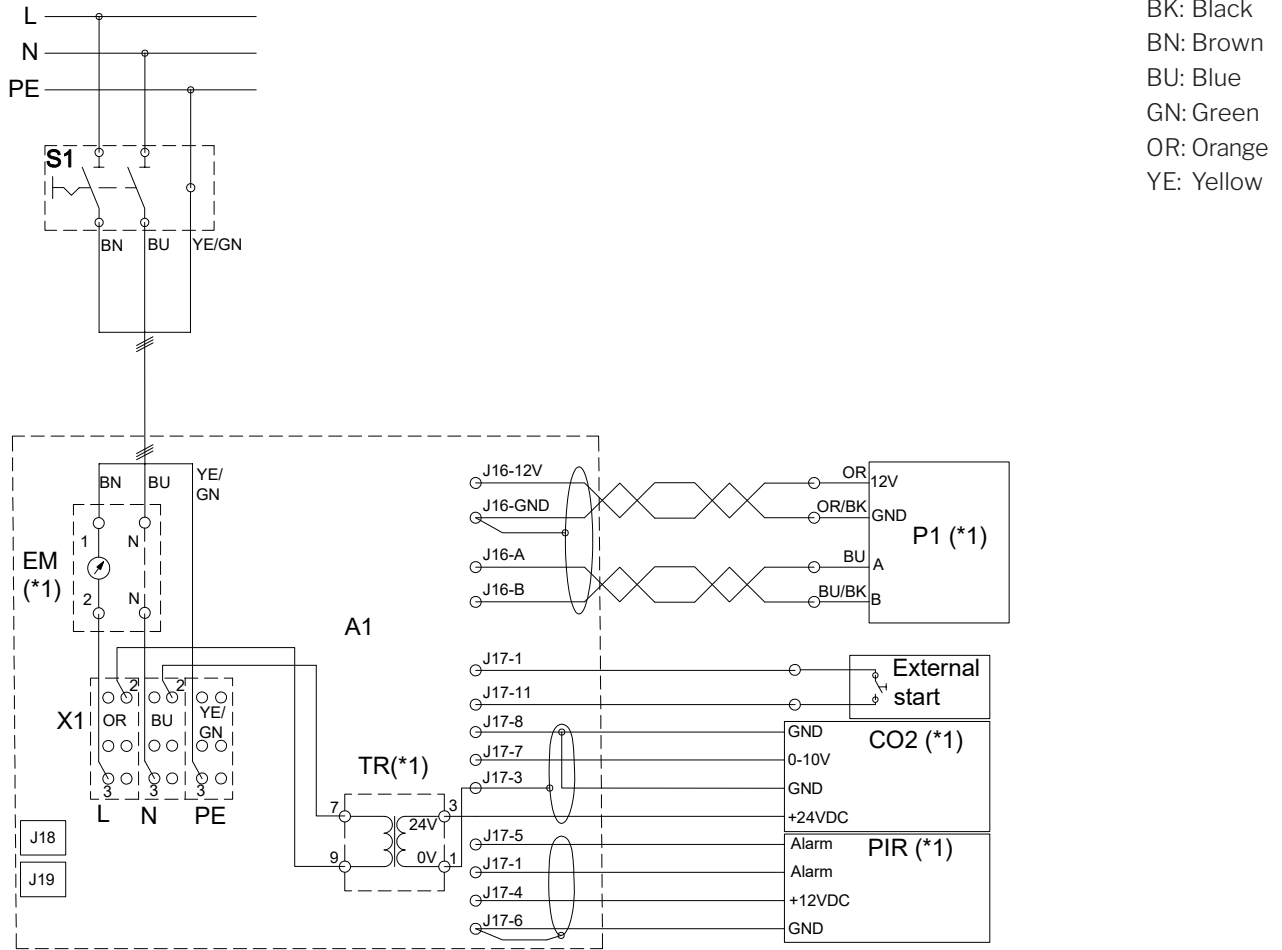

J6 Plug, RS485  
J6-A + RS485 (A)  
J6-B - RS485 (B)

J16 Plug, control panel  
J16-12V 12 VDC output  
J16-GND GND  
J16-A + RS485 (A)  
J16-B - RS485 (B)

J17 Plug, option connection  
J17-1 13.5 VDC output  
J17-3 GND  
J17-4 13.5 VDC output  
J17-5 PIR (AI#1) or External Stop/analogue BMS Start (input 0-10VDC or 13,5VDC)  
J17-6 GND  
J17-7 0-10 Volt CO<sub>2</sub> signal (AI#2) or analogue BMS flow or analogue BMS temperature/External Stop (input 0-10VDC or 13,5VDC)  
J17-8 GND  
J17-11 External start (AI#3) or External Stop/analogue BMS Start (input 0-10VDC or 13,5VDC)  
J17-12 GND

J18 BMS plug (LON<sup>®</sup>, KNX<sup>®</sup>, MODBUS<sup>®</sup>, BACnet<sup>™</sup>), Ethernet

J15/J19 Mini-B USB plug (PC connection)

(\*1) Option  
A1 Air handling unit  
B1 PIR/motion sensor (wall mounted) (\*1)  
B2 CO<sub>2</sub> sensor (wall mounted) (\*1)  
EM Energy meter (\*1)  
P1 Control panel (\*1)  
S1 Supply separator (not supplied by Airmaster)  
TR Power supply 24 Volt DC (\*1)  
X1 Terminal clamps, power supply

External Stop, Boost, analogue BMS start - see section "Connection of electrical equipment".

**All digital and analogue inputs can be programmed using the "Airlinq Service Tool".**

## Standard connections AM 500 and 800 with AQC-L (black control box)

BK: Black  
 BN: Brown  
 BU: Blue  
 GN: Green  
 OR: Orange  
 YE: Yellow

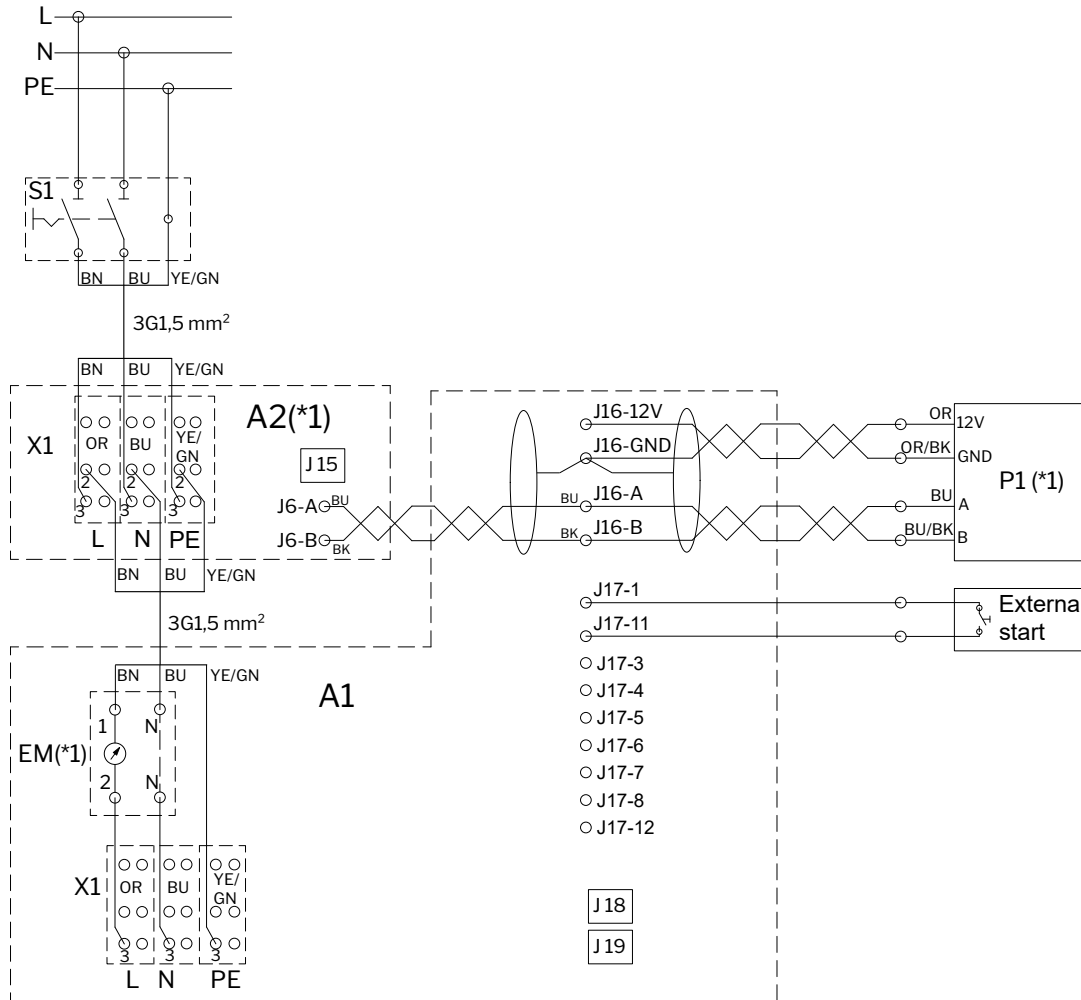

J6	Plug, RS485	J18	BMS plug (LON®, KNX®, MODBUS®, BACnet™), Ethernet
J6-A	+ RS485 (A)	J15/J19	Mini-B USB plug (PC connection)
J6-B	- RS485 (B)	(*1)	Option
J16	Plug, control panel	A1	Air handling unit
J16-12V	12 VDC output	A2	Cooling module (*1)
J16-GND	GND	B1	PIR/motion sensor (wall mounted) (*1)
J16-A	+ RS485 (A)	B2	CO <sub>2</sub> sensor (wall mounted) (*1)
J16-B	- RS485 (B)	EM	Energy meter (*1)
J17	Plug, option connection	P1	Control panel (*1)
J17-1	13.5 VDC output	S1	Supply separator (not supplied by Airmaster)
J17-3	GND	TR	Power supply 24 Volt DC (*1)
J17-4	13.5 VDC output	X1	Terminal clamps, power supply
J17-5	PIR (AI#1) or External Stop/analogue BMS Start (input 0-10VDC or 13,5VDC)		
J17-6	GND		
J17-7	0-10 Volt CO <sub>2</sub> signal (AI#2) or analogue BMS flow or analogue BMS temperature/External Stop (input 0-10VDC or 13,5VDC)		
J17-8	GND		
J17-11	External start (AI#3) or External Stop/analogue BMS Start (input 0-10VDC or 13,5VDC)		
J17-12	GND		

External Stop, Boost, analogue BMS start - see section "Connection of electrical equipment".

**All digital and analogue inputs can be programmed using the "Airlinq Service Tool".**



Standard connections AM 500, 800 and 900 with AQC-P (grey control box)

BK: Black  
 BN: Brown  
 BU: Blue  
 GN: Green  
 OR: Orange  
 YE: Yellow

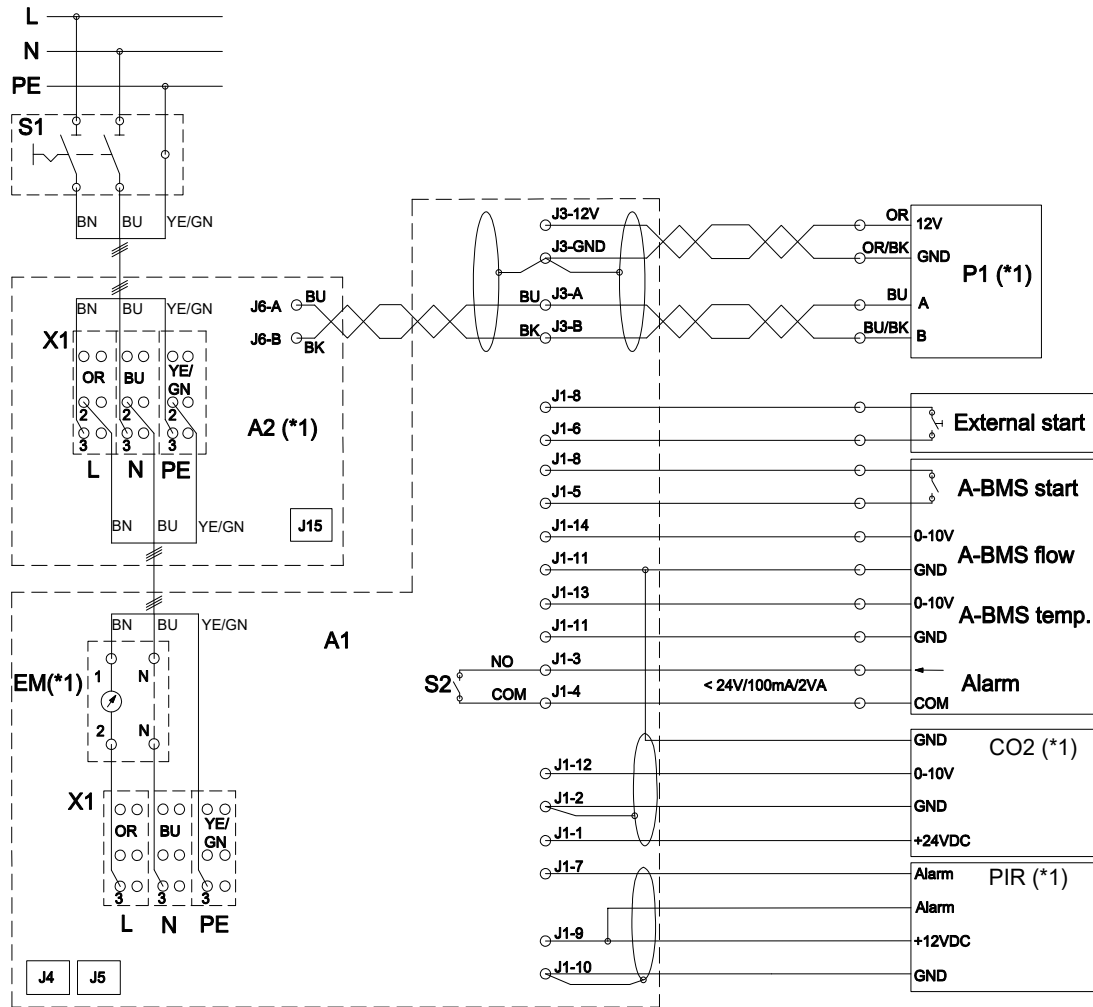

- |        |   |        |   |
|--------|---|--------|---|
| J1     | Plug, option connection   | J4/J15 | Mini-B USB plug (PC connection)                   |
| J1-1   | 24 V (DC) output, one sensor  | J5     | BMS plug (LON®, KNX®, MODBUS®, BACnet™), Ethernet |
| J1-2   | GND (24 V)  | J6     | Plug, RS485                                       |
| J1-3   | Alarm terminal clamp 1 (NO)   | J6-A   | + RS485 (A)                                       |
| J1-4   | Alarm terminal clamp 2  | J6-B   | - RS485 (B)                                       |
| J1-5   | Analogue BMS Start/External Stop, digital input (DI#3)                                  | (*1)   | Option  |
| J1-6   | External start, digital input (DI#2)  | A1     | Air handling unit                                 |
| J1-7   | PIR signal, digital input (DI#1)  | A2     | Cooling module (*1; AM 500 and 800)               |
| J1-8   | 12 V (DC) output  | B1     | PIR/motion sensor (wall mounted) (*1)             |
| J1-9   | 12 V (DC) output  | B2     | CO <sub>2</sub> sensor (wall mounted) (*1)        |
| J1-10  | GND PIR   | EM     | Energy meter (*1)                                 |
| J1-11  | GND (CO <sub>2</sub> signal, analogue BMS flow signal, analogue BMS temperature signal) | P1     | Control panel (*1)                                |
| J1-12  | 0-10 Volt CO <sub>2</sub> signal input (AI#3)   | S1     | Supply separator (not supplied by Airmaster)      |
| J1-13  | 0-10 Volt analogue BMS temperature signal input (AI#2)                                  | S2     | Alarm contact                                     |
| J1-14  | 0-10 Volt analogue BMS flow signal input (linear) (AI#1)                                | X1     | Terminal clamps, power supply                     |
| J3     | Plug, control panel   |        |   |
| J3-12V | 12 V (DC) output  |        |   |
| J3-GND | GND (12 V)  |        |   |
| J3-A   | + RS485 (A)   |        |   |
| J3-B   | - RS485 (B)   |        |   |

External Stop, Boost - see section "Connection of electrical equipment".

All digital and analogue inputs can be programmed using a PC with the "Airlinq Service Tool".

Standard connections AM 1000 with AQC-P (grey control box), single-phase connection

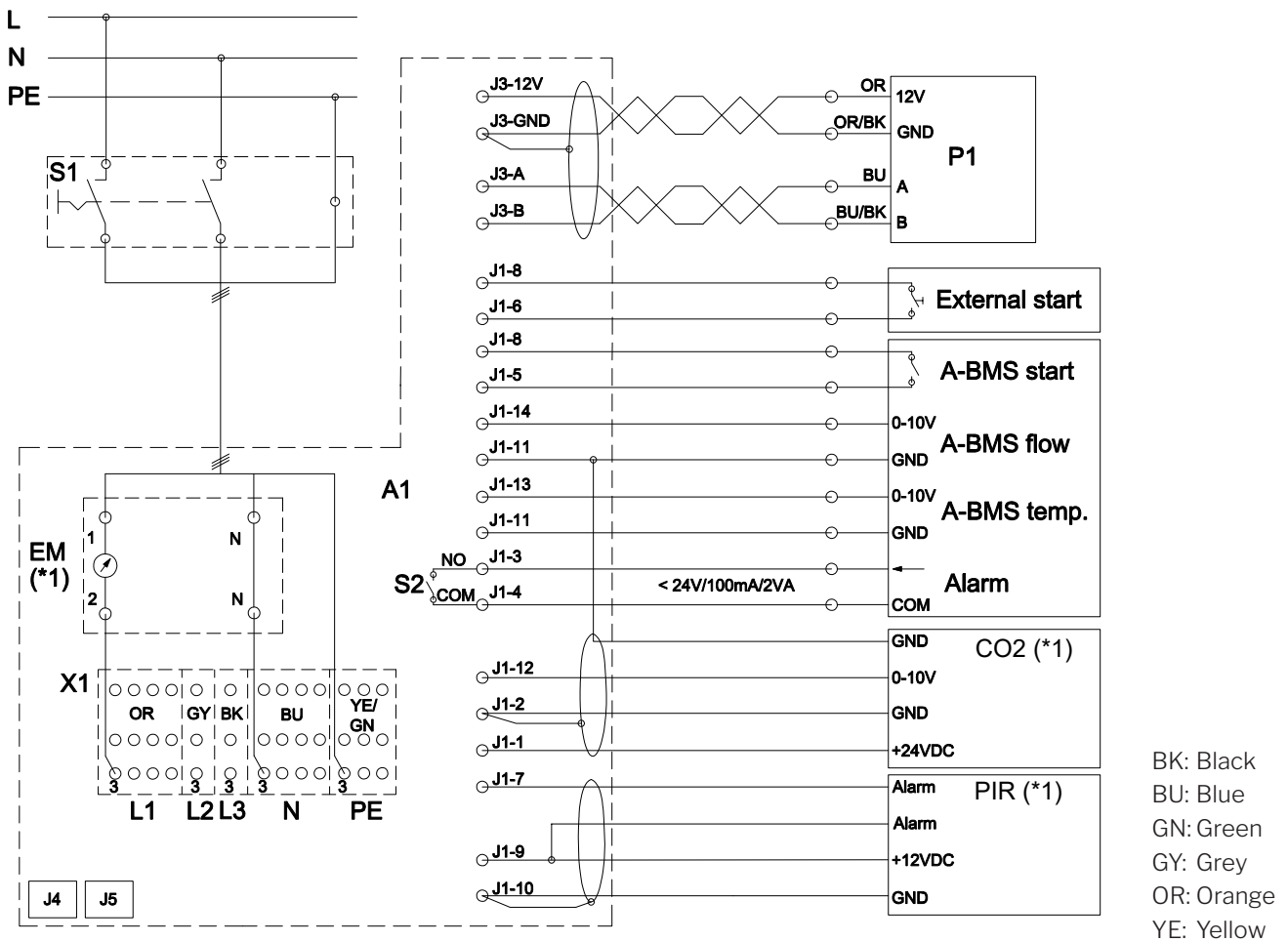

- |        |   |      |   |
|--------|---|------|---|
| J1     | Plug, option connection   | J4   | Mini-B USB plug (PC connection)                   |
| J1-1   | 24 V (DC) output, one sensor  | J5   | BMS plug (LON®, KNX®, MODBUS®, BACnet™), Ethernet |
| J1-2   | GND (24 V)  | (*1) | Option  |
| J1-3   | Alarm terminal clamp 1 (NO)   | A1   | Air handling unit                                 |
| J1-4   | Alarm terminal clamp 2  | B1   | PIR/motion sensor (wall mounted) (*1)             |
| J1-5   | Analogue BMS Start/External Stop, digital input (DI#3)                                  | B2   | CO <sub>2</sub> sensor (wall mounted) (*1)        |
| J1-6   | External start, digital input (DI#2)  | EM   | Energy meter (*1)                                 |
| J1-7   | PIR signal, digital input (DI#1)  | P1   | Control panel                                     |
| J1-8   | 12 V (DC) output  | S1   | Supply separator (not supplied by Airmaster)      |
| J1-9   | 12 V (DC) output  | S2   | Alarm contact                                     |
| J1-10  | GND PIR   | X1   | Terminal clamps, power supply                     |
| J1-11  | GND (CO <sub>2</sub> signal, analogue BMS flow signal, analogue BMS temperature signal) |      |   |
| J1-12  | 0-10 Volt CO <sub>2</sub> signal input (AI#3)   |      |   |
| J1-13  | 0-10 Volt analogue BMS temperature signal input (AI#2)                                  |      |   |
| J1-14  | 0-10 Volt analogue BMS flow signal input (linear) (AI#1)                                |      |   |
| J3     | Plug, control panel   |      |   |
| J3-12V | 12 V (DC) output  |      |   |
| J3-GND | GND (12 V)  |      |   |
| J3-A   | + RS485 (A)   |      |   |
| J3-B   | - RS485 (B)   |      |   |
- External Stop, Boost - see section "Connection of electrical equipment".
- All digital and analogue inputs can be programmed using a PC with the "Airlinq Service Tool".

## Standard connections AM 1000 and 1200 with AQC-P (grey control box)

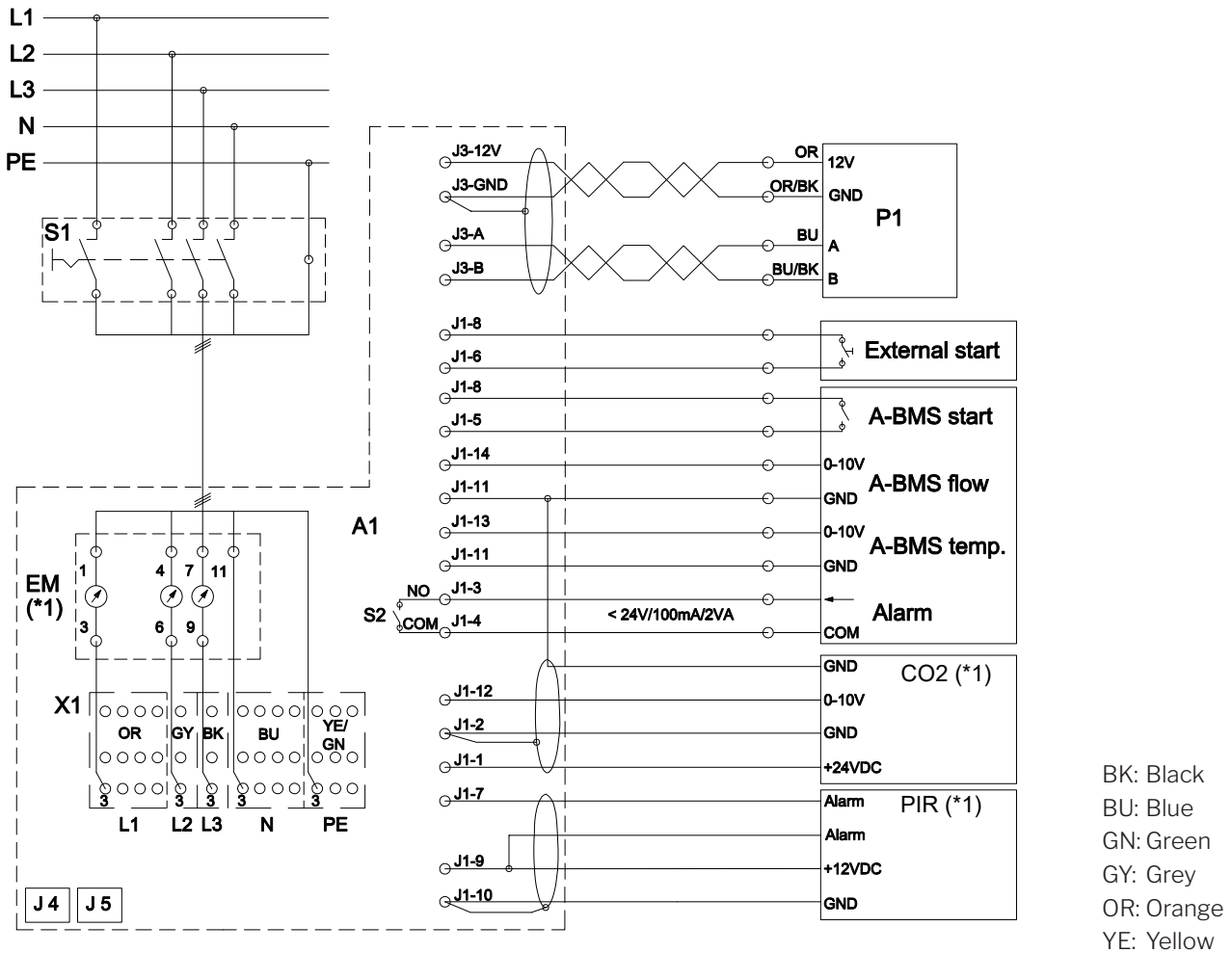

J3-A + RS485 (A)  
 J3-B - RS485 (B)

- J1 Plug, option connection
- J1-1 24 V (DC) output, one sensor
- J1-2 GND (24 V)
- J1-3 Alarm terminal clamp 1 (NO)
- J1-4 Alarm terminal clamp 2
- J1-5 Analogue BMS Start/External Stop, digital input (DI#3)
- J1-6 External start, digital input (DI#2)
- J1-7 PIR signal, digital input (DI#1)
- J1-8 12 V (DC) output
- J1-9 12 V (DC) output
- J1-10 GND PIR
- J1-11 GND (CO<sub>2</sub> signal, analogue BMS flow signal, analogue BMS temperature signal)
- J1-12 0-10 Volt CO<sub>2</sub> signal input (AI#3)
- J1-13 0-10 Volt analogue BMS temperature signal input (AI#2)
- J1-14 0-10 Volt analogue BMS flow signal input (linear) (AI#1)
  
- J3 Plug, control panel
- J3-12V 12 V (DC) output
- J3-GND GND (12 V)

- J4 Mini-B USB plug (PC connection)
- J5 BMS plug (LON®, KNX®, MODBUS®, BACnet™), Ethernet

- (\*1) Option
- (\*2) AM 1200: For single-phase connection without electric heating surfaces, connect L1, N and PE by means of a 3G2.5 mm<sup>2</sup> cable. The supply can be limited to a single-phase, connected to L1. Only for air handling units without electric heating surface.

- A1 Air handling unit
- B1 PIR/motion sensor (wall mounted) (\*1)
- B2 CO<sub>2</sub> sensor (wall mounted) (\*1)
- EM Energy meter (\*1)
- P1 Control panel
- S1 Supply separator (not supplied by Airmaster)
- S2 Alarm contact
- X1 Terminal clamps, power supply

External Stop, Boost - see section "Connection of electrical equipment".

All digital and analogue inputs can be programmed using a PC with the "Airlinq Service Tool".

- This page is intentionally left blank -

## Connecting the AM 1000 sections

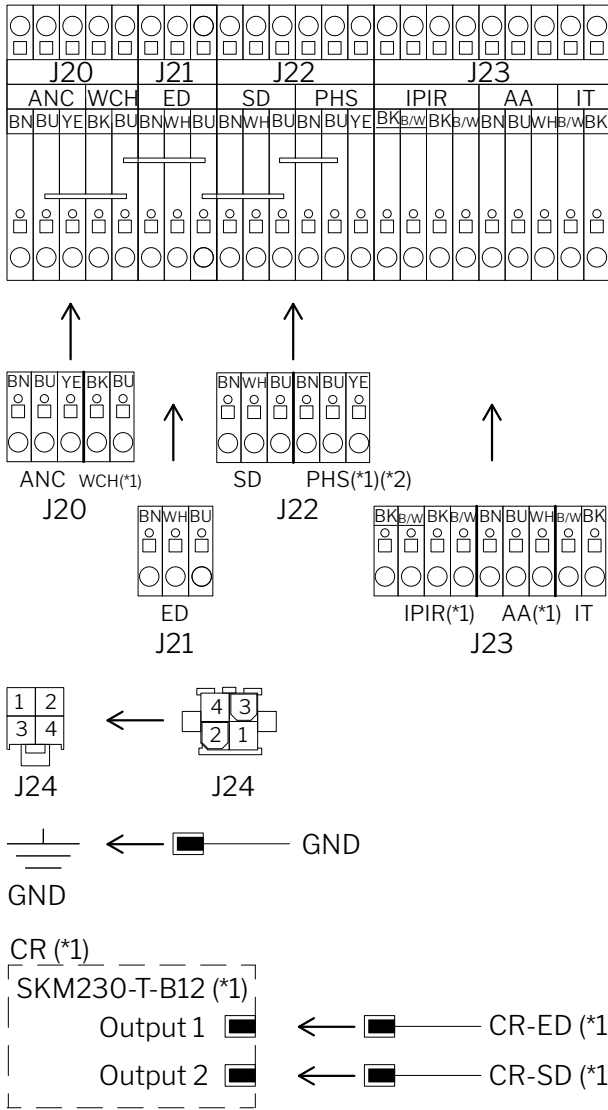

- J20 Plug 1 left section
- J21 Plug 2 left section / plug 2 right section
- J22 Plug 1 right section
- J23 Plug 1 front section
- J24 Plug 2 front section to plug 3 left section (ANC)
- CR Capacitive Return (\*1)
- CR-ED Exhaust Air Damper Capacitive Return (\*1)
- CR-SD Supply Air Damper Capacitive Return (\*1)
- SKM Capacity Unit Capacitive Return (\*1)

- (\*1) Option
- (\*2) Not single-phase AM 1000

## Connecting the AM 1000 and RC 1000 sections

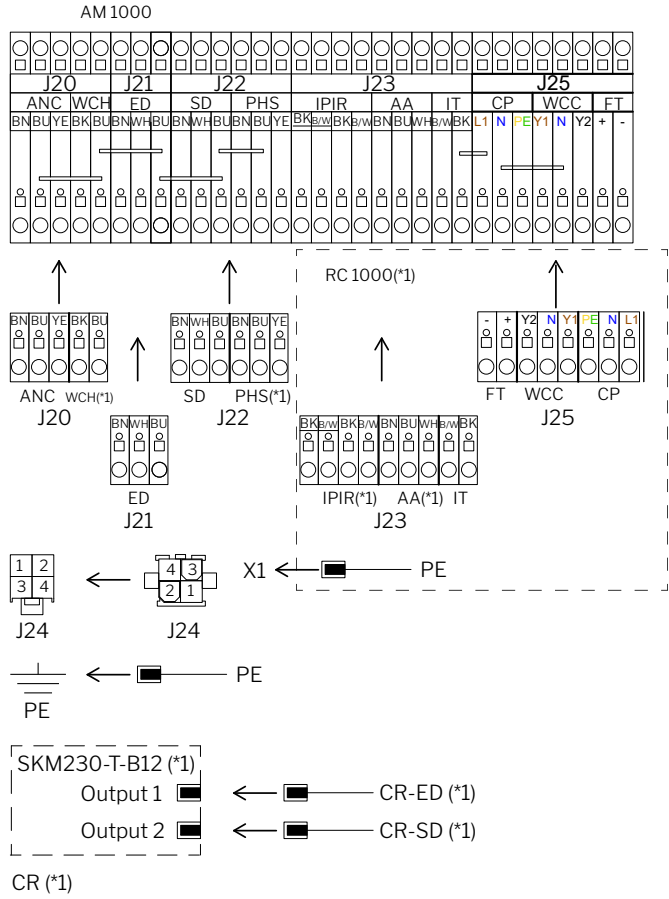

- J20 Plug 1 left section
- J21 Plug 2 left section / plug 2 right section
- J22 Plug 1 right section
- J23 Plug 1 RC 1000 section
- J24 Plug 2 front section to plug 3 left section (ANC)
- J25 Plug 2 RC1000 section
- X1 Terminal clamps, power supply
- CR Capacitive Return (\*1)
- CR-ED Exhaust Air Damper Capacitive Return (\*1)
- CR-SD Supply Air Damper Capacitive Return (\*1)
- SKM Capacity Unit Capacitive Return (\*1)

- (\*1) Option
- (\*2) Not single-phase AM 1000

## Connecting the AM 1000 sections with build-in smoke detector (option)

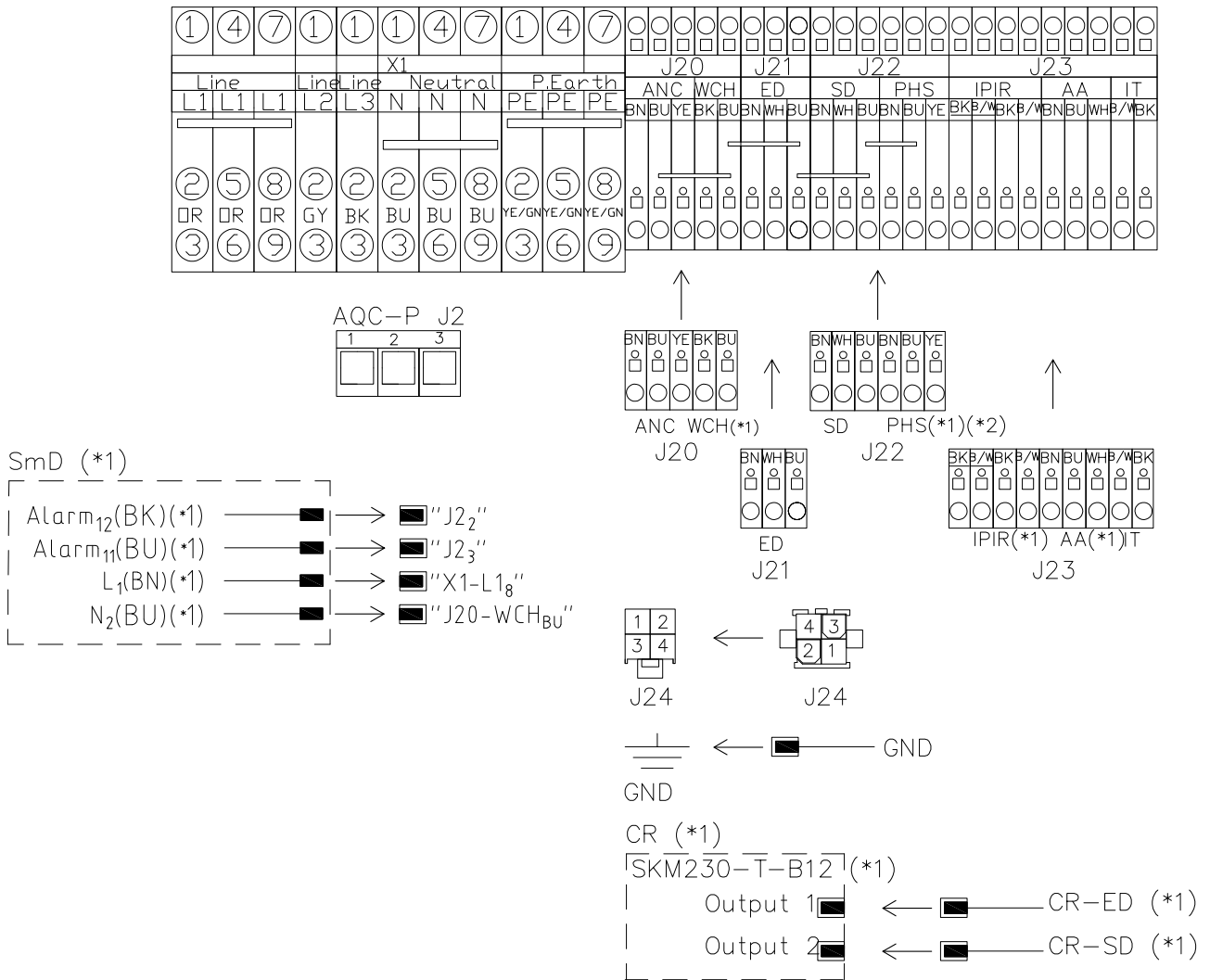

- J2 AQC J2
- J20 Plug 1 left section
- J21 Plug 2 left section / plug 2 right section
- J22 Plug 1 right section
- J23 Plug 1 front section
- J24 Plug 2 front section to plug 3 left section (ANC)

- CR Capacitive Return (\*1)
- CR-ED Exhaust Air Damper Capacitive Return (\*1)
- CR-SD Supply Air Damper Capacitive Return (\*1)
- SKM Capacity Unit Capacitive Return (\*1)

X1 Terminal clamps, power supply

- SmD Smoke detector (\*1) (front section)
- SmD Alarm Smoke detector alarm (\*1)
- SmD L Phase (\*1)
- SmD N Neutral (\*1)

- (\*1) Option
- (\*2) Not single-phase AM 1000

## Connecting the AM 1200 sections

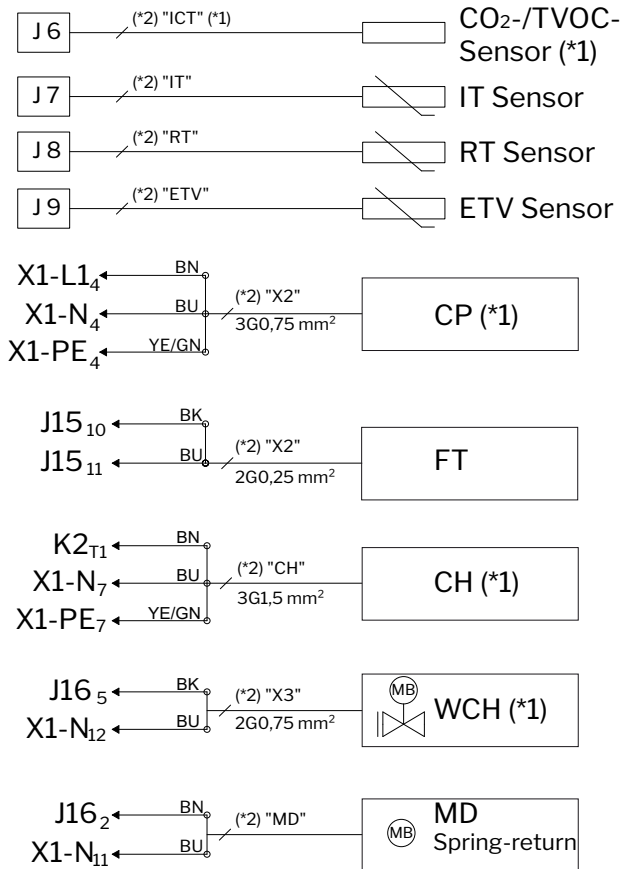

BK: Black      BU: Blue      YE: Yellow  
 BN: Brown      GN: Green

- X1 Terminal clamps, power supply (L1 – Phase 1, N – Neutral, PE – Earth)
- X2 Terminal clamps, condensate pump (CP) and condensate float (FT)
- J6 Plug, internal CO<sub>2</sub>/TVOC sensor (ICT)
- J7 Plug, inlet temperature sensor (IT)
- J8 Plug, room temperature sensor (RT)
- J9 Plug, exhaust temperature sensor (ETV)
- J15-10 Input 1 Condensate float (FT)
- J15-11 Input 2 Condensate float (FT)
- J16-2 Power supply (230 V) Main damper (MD) (Connection only for models with roof ducts)
- J16-5 Power supply (230 V) Water comfort heater (WCH)
- K2 Relay for electrical comfort heater (CH)

- (\*1) Option
- (\*2) Wire label

## Standard connections DV 1000 with AQC-P (grey control box)

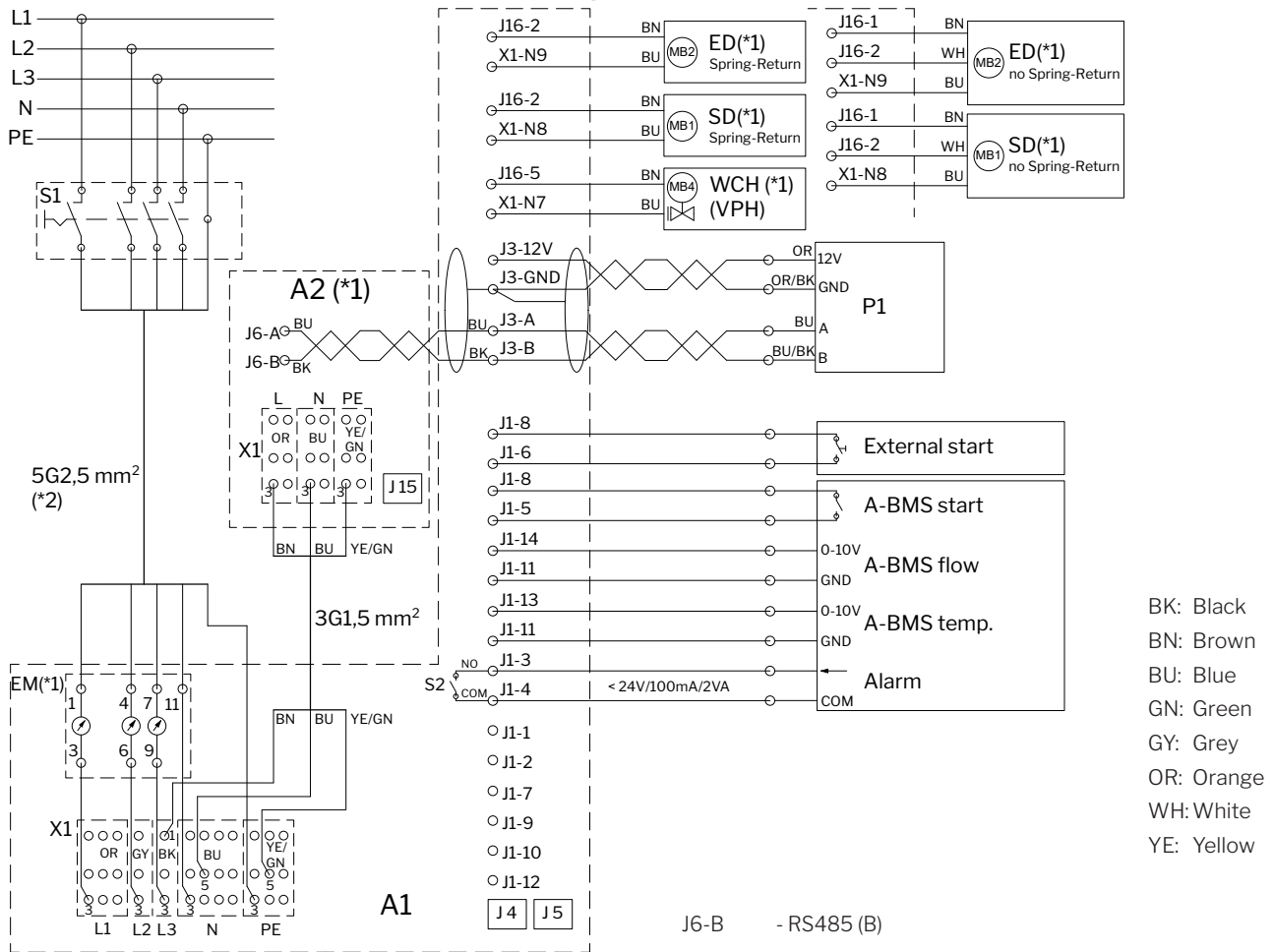

J1	Plug, option connection
J1-1	24 V (DC) output, one sensor
J1-2	GND (24 V)
J1-3	Alarm terminal clamp 1 (NO)
J1-4	Alarm terminal clamp 2 (COM)
J1-5	Analogue BMS Start/External Stop, digital input DI#3
J1-6	External start, digital input DI#2
J1-7	PIR signal, digital input DI#1
J1-8	12 V (DC) output
J1-9	12 V (DC) output
J1-10	GND PIR
J1-11	GND (CO <sub>2</sub> signal, analogue BMS flow signal, analogue BMS temperature signal)
J1-12	0-10 Volt CO <sub>2</sub> signal input, AI#3
J1-13	0-10 Volt analogue BMS temperature signal input, AI#2
J1-14	0-10 Volt analogue BMS flow signal input (linear), AI#1
J3	Plug, control panel
J3-12V	12 V (DC) output
J3-GND	GND (12 V)
J3-A	+ RS485 (A)
J3-B	- RS485 (B)
J4/J15	Mini-B USB plug (PC connection)
J5	BMS plug (LON®, KNX®, MODBUS®, BACnet™), Ethernet
J6	Plug, RS485
J6-A	+ RS485 (A)

J16	Plug 230 V (AC) relays
J16-1	230 V (AC) output
J16-2	230 V (AC) output
J16-5	230 V (AC) output
(*1)	Option
(*2)	For single-phase connection without electric heating surfaces, connect L1, N and PE by means of a 3G2.5 mm <sup>2</sup> cable. The supply can be limited to a single-phase, connected to L1. Only for air handling units without electric heating surface.
A1	Ventilation unit
A2	Cooling module (*1)
B1	PIR/motion sensor (wall mounted) (*1)
B2	CO <sub>2</sub> sensor (wall mounted) (*1)
ED	External exhaust air damper (*1)
EM	Energy meter (*1)
P1	Control panel
SD	External supply air damper (*1)
S1	Supply separator (not supplied by Airmaster)
S2	Alarm contact
WCH	External water comfort heater (*1)
X1	Terminal clamps, power supply
N7	Neutral pin 7
N8	Neutral pin 8
N9	Neutral pin 9

Boost, External Stop - see section "Connection of electrical equipment".

All digital and analogue inputs can be programmed using the "Airlinq Service Tool".



# Wiring diagrams for typical Airlinq BMS systems

## Individual units, one system control panel

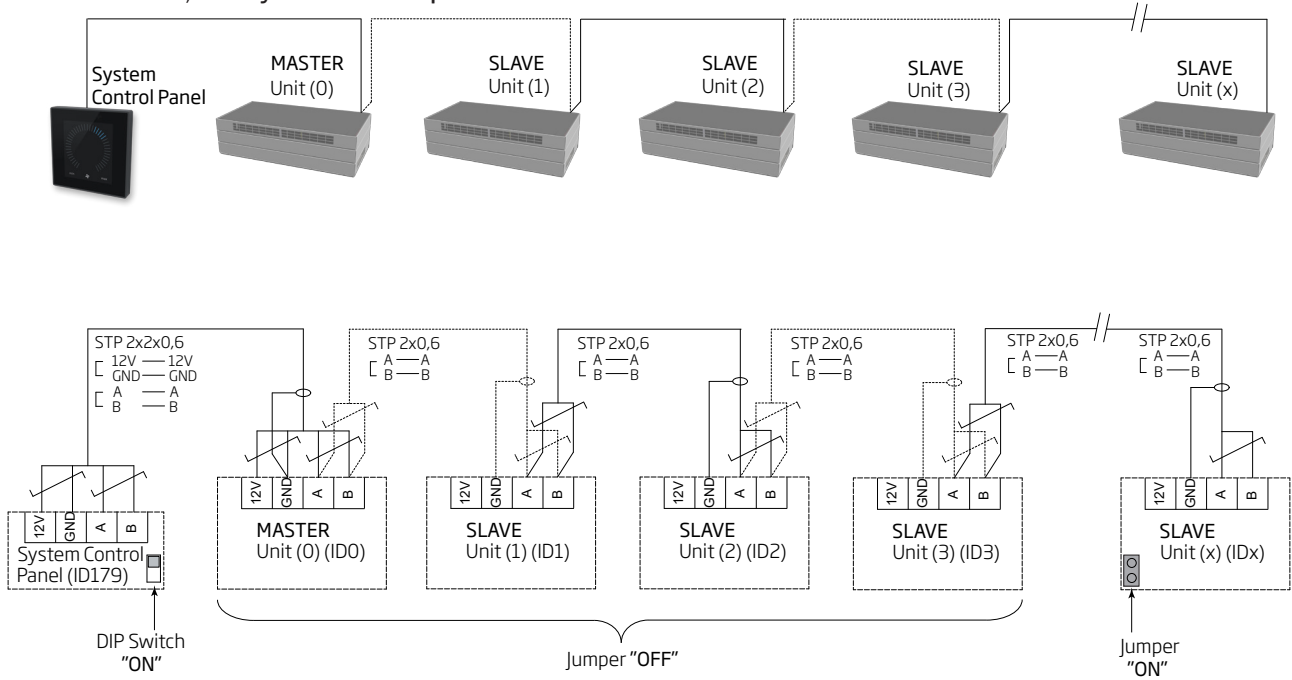

## Individual units with cooling module, one system control panel

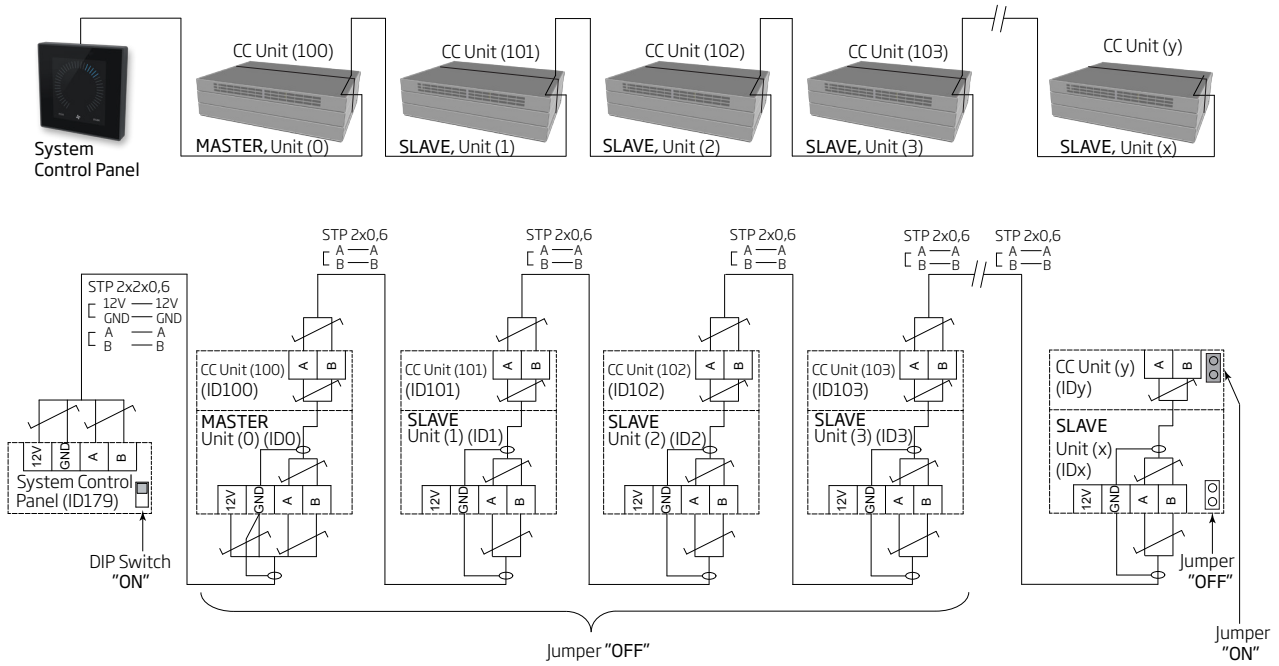

Individual units with cooling module and group control panels, one system control panel

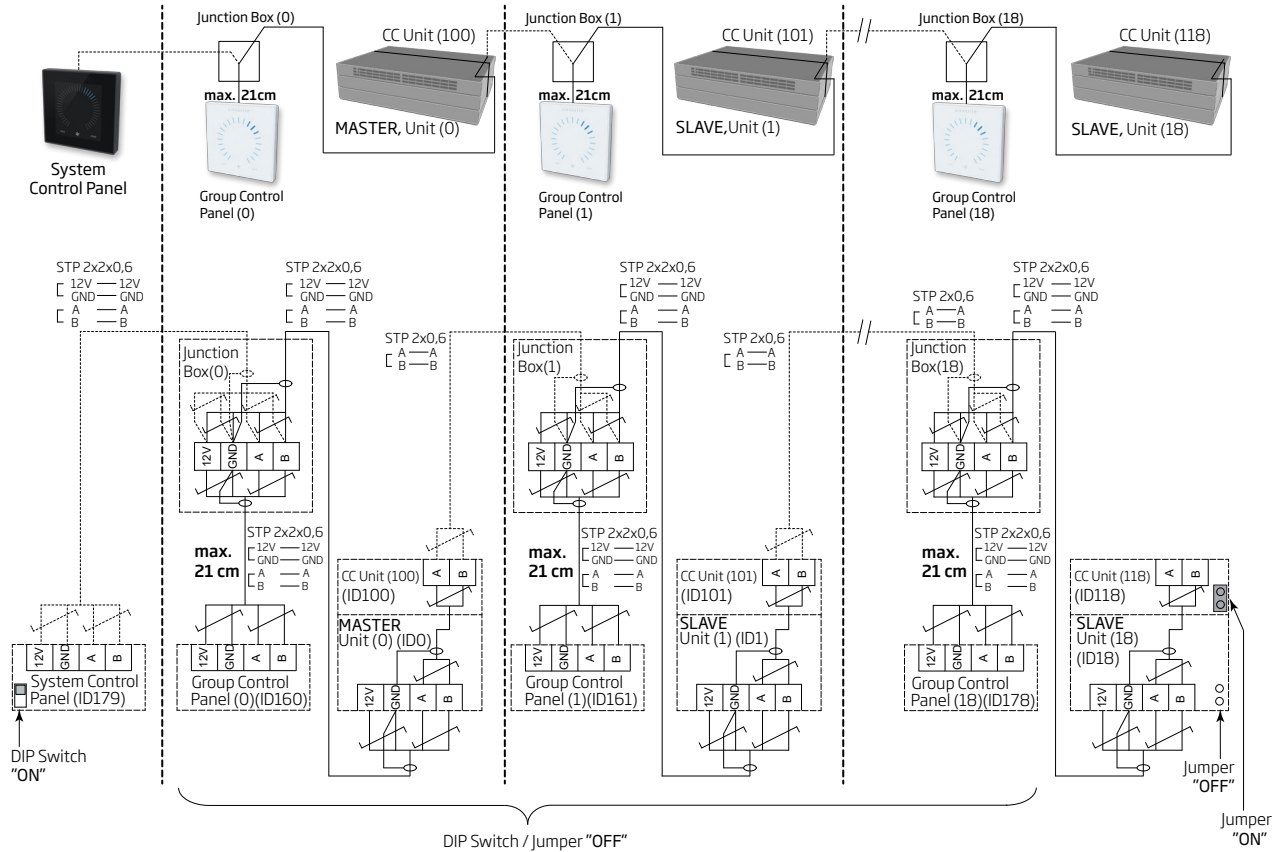

The junction box must be installed in the immediate vicinity of the control panel. Cables longer than 21 cm are not permitted and may lead to communication errors.



## BMS connections

The network plug for AM 500, 800, 900, 1000 and 1200, DV 1000 with AQC-P (grey control box) is named J5.

The network plug for AM 150, 300, 500 and 800 with AQC-L (black control box) is named J18.

*Wiring must be connected according to the BMS standard.*

*Further information on the D-BMS documentation is available on Airmaster's website: [www.airmaster-as.com](http://www.airmaster-as.com).*

## LON®

### Connection

J5/J18	Bus-A input and Bus-B input (polarity irrelevant)
D1	LON® status LED, red
S1	Service Pin (test button)

### Test

Status LED flashes.

### Identification

Each individual network module has a Neuron® ID. The ID number is located on a label delivered with the module/glued onto the control box in the unit. For example:

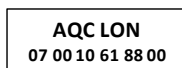

When programming, you can press the test button on the network module to identify the units.

### Cable recommendation

A list of cables that comply with "Echelon® wire guidelines" is available at <http://www.echelon.com/> ("Junction Box and Wiring Guidelines' engineering bulletin").

## KNX®

### Connection

grey	KNX® GND
red	KNX® +
D1	KNX® status LED, green
SW2	KNX® key, test button

### Test

Status LED is green during programming.

### Addressing

Each individual network module is supplied with the same address: 15.15.254.

Press the test button on the network module to identify the units and establish communication. The test button puts the units into programming mode, enabling among other things change of address to a unique address in the system.

### Cable recommendation

KNX®-registered, certified data cable (Twisted Pair (TP) or Shielded Twisted Pair (STP)). A list is available on the internet at <https://www.knx.org>.

### Connection of units

2 twisted-pair wires (1 pair) for KNX® GND and KNX® +

According to "KNX Association guidelines" [KNX® TP1 Installation, KNX® Association] it is not usually necessary to connect the shield to the data cable if a typical standard KNX® cable (e.g. KNX® TP1) is used in the installation.

## BACnet™/IP

### Connection

- Port 1 INPUT (3)
- Port 2 OUTPUT (4)
- NS Network Status LED (1)
- MS Module Status LED (2)
- Link/Activity Port 1 (5) og Port 2 (6)

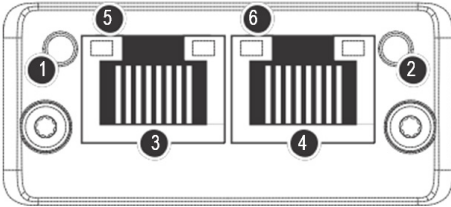

### Test

Scanning of the network (e.g. using the IP configuration tool program, which is available on Airmaster's website) using a PC connected directly to the network module or control of MS LED (green light).

### Identification

Each individual network module has a unique unit ID. The ID number is located on a label delivered with the module/ glued onto the control box in the unit. For example:

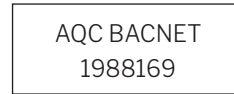

The identification number can be read from the status window, using the Airlinq Service Tool.

### Cable recommendation

At least one AWG 24 CAT 5e STP (Shielded Twisted Pair) data cable with RJ45 connector. The maximum recommended length for an IP segment with AWG 24 cables is 70 metres.

### Connection of units

With AQC-L (black control box):

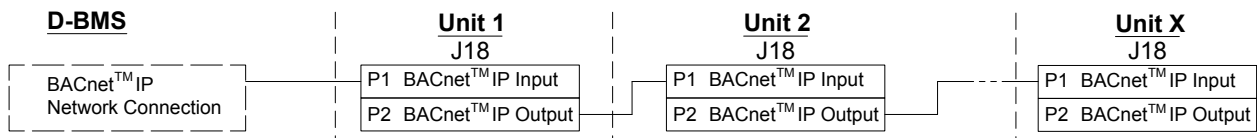

With AQC-P (grey control box):

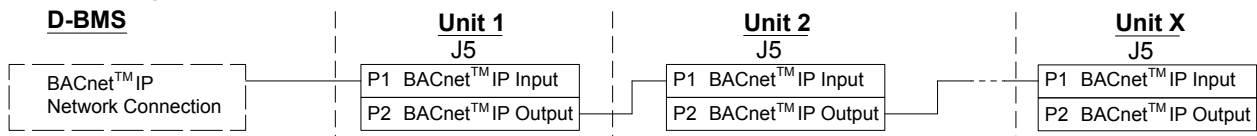

## BACnet™ MS/TP

### Connection

- 1 NS: Network Status LED
- 2 MS: Module Status LED
- 3 BACnet™ plug
  - Pin 1 Signal common / GND
  - Pin 2 Data - / Bus-B
  - Pin 3 Shield
  - Pin 4 Data + / Bus-A
  - Pin 5 ./.

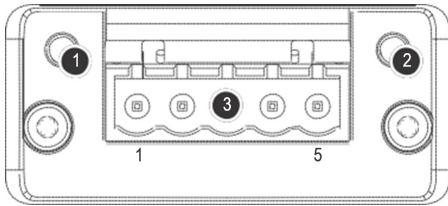

### Test

MS LED is green.

### Connection

Each individual network module has a unique unit ID. The ID number is located on a label delivered with the module/ glued onto the control box in the unit. For example:

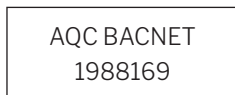

The identification number can be read from the status window, using the Airlinq Service Tool.

### Addressing

Index	Parameter	Name	Value
128	ID405	Bacnet MS/TP Adress	0
129	ID406	Bacnet MS/TP Baud Rate	9600

Addressing can be performed using the Airlinq Service Tool or directly via the network.

**BACnet™ MS/TP systems must be terminated according to the system's standard.**

### Cable recommendation

Shielded Twisted Pair (STP) data cable (2+1 or 2x2) according to "ANSI/ASHRAE Addendum to ANSI/ASHRAE Standard 135-2008".

Characteristic impedance between 100 and 130 ohms. Capacitance between the wires must be less than 100 pF per metre. Maximum recommended length in an MS/TP segment with an AWG 18 cable is 1200 m. The shield is placed on the frame according to the drawing below.

### Connection of units

With AQC-L (black control box):

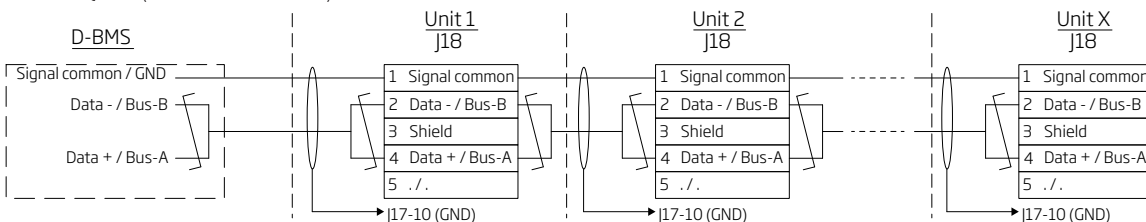

With AQC-P (grey control box):

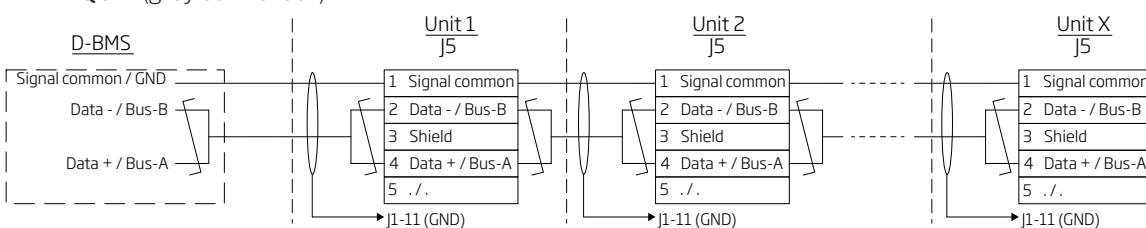

# MODBUS® RTU RS485

## Connection

### MODBUS® plug

- Pin 1 Signal common / GND
- Pin 2 Bus-B input
- Pin 3 Bus-B output
- Pin 4 Bus-A input
- Pin 5 Bus-A output

- D9 MODBUS® communication, yellow LED
- D8 MODBUS® error, red LED

### DIP switch settings:

- SW1: "On" for the first and last unit in the chain. "Off" for all other units.
- SW2/3: "On" when the bus requires "failsafe biasing", or "Off"

## Test

LED D8 signals a fault (flashes red) until the module is programmed.

## Addressing

Register	Parameter	Designation	Value
40001	ID402	Modbus Address	3
40002	ID403	Modbus Baud Rate	19200
40003	ID404	Modbus Parity	Even (1 Stop bit)

Addressing can be performed using the Airlinq Service Tool or directly via the network.

**DIP switches SW1, 2 and 3 must be set in compliance with the system's standard and installation.**

## Cable recommendation

Shielded Twisted Pair (STP) data cable (2+1 or 2x2) according to "Modbus Serial Line Protocol and Implementation Guide V1.02" [www.modbus.org](http://www.modbus.org).

An AWG 24 STP data cable (2+1 or 2x2) is usually adequate for MODBUS® data communication. The shield is placed on the frame according to the drawing below.

## Connection of units

### With AQC-L (black control box):

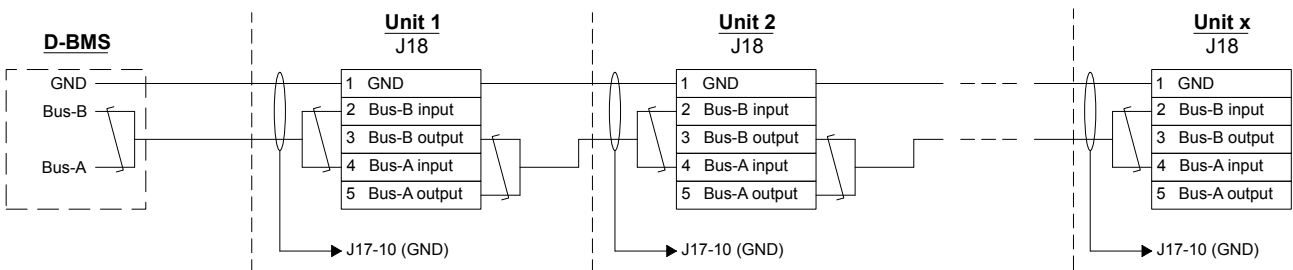

### With AQC-P (grey control box):

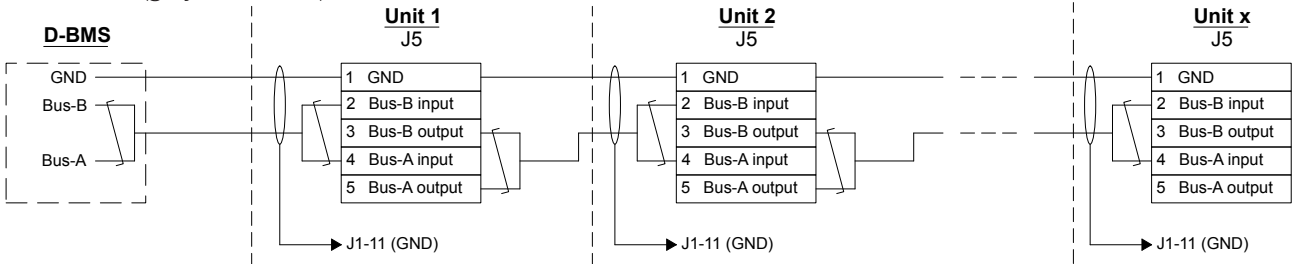

# Airmaster Airlinq® Online (Ethernet)

## Connection

- Status LED (1)
- Port - Input (2)
- Port LED (3)

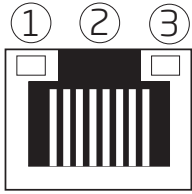

## Identification

Each network module has a unique MAC address on delivery. The MAC address is located on a label delivered with the module/glued onto the control box in the unit. For example:

Ethernet MAC  
00:1E:C0:DB:27:A3

The unit's serial number is transferred to the network module. After it has been connected to the internet, you can communicate with the unit via Airlinq Online.

The Ethernet card should be connected to a switch/hub with a patch cable to establish a connection to Airlinq Online.

## Test

The status diode is orange when the unit is connected to the power supply. When the module is connected to a local network, the port diode is green.

## Cable recommendation

At least one AWG 24 CAT 5e STP (Shielded Twisted Pair) data cable with RJ45 connector. The maximum recommended length for an IP segment with AWG 24 cables is 70 metres.

## Connection of units

With AQC-L (black control box):

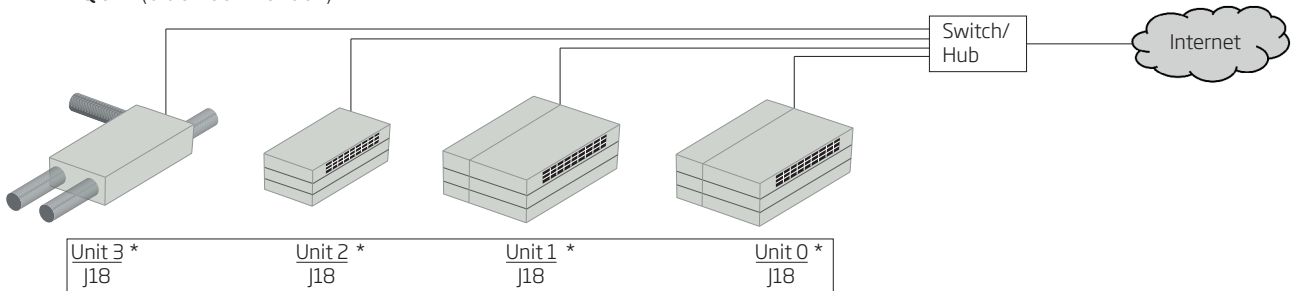

With AQC-P (grey control box):

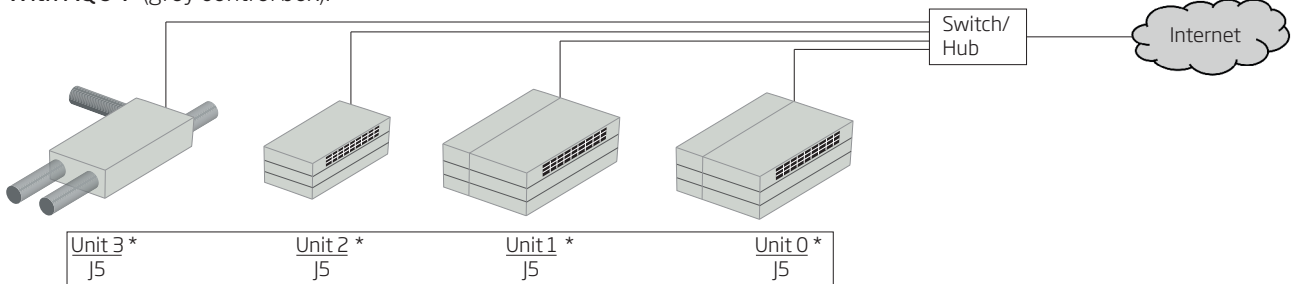

## Airlinq BMS + Airmaster Airlinq® Online

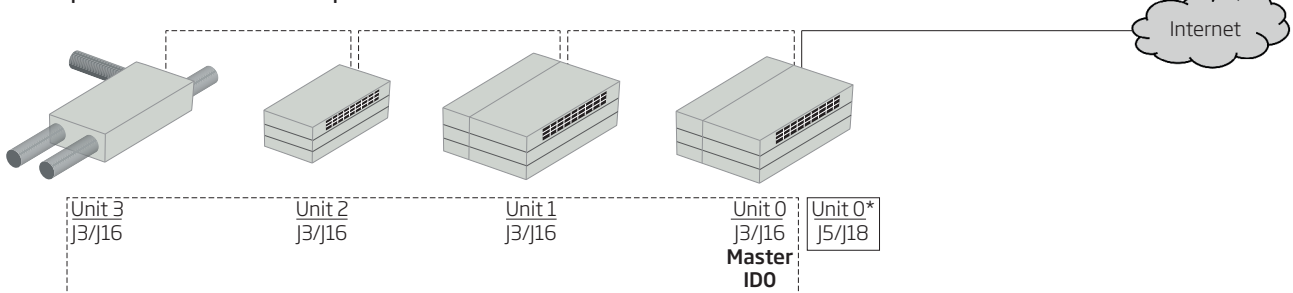

- Airlinq BMS (See section "Airlinq BMS Installation")
- Airmaster Airlinq® Online
- \* Airlinq Servie Tool: D-BMS Type = "Ethernet" (Parameter ID400)



## Appendix 2 Error descriptions

Start-up problems may be due to a simple installation error. You should therefore read through the error descriptions below to ensure that installation has been carried out correctly.

**Error 1:** Control panel air indicator flashing simultaneously on the left and right side (Airlinq Viva) or running from one side to the other (Airlinq Orbit).

Cause: Data connection from control panel to unit disconnected

**Error 2:** None of the equipment with a 12 volt supply is functioning.

Cause: The leads to "0-10 V" and "GND" are the wrong way round.

**Error 3:** Filter alarm activates shortly after installation. (DV 1000 only)

Cause: Operating point not set correctly.

Reduce air volume set point using a PC running the Airlinq Service Tool.

**Error 4:** Inlet temperature (IT) outside normal values. (DV 1000 only)

Cause: Inlet temperature sensor not correctly installed. Further information is available in the "External Components" section of the installation manual.

Further error descriptions can be found in the "Operation and Maintenance" manual.

## Error at Airlinq BMS

**Error 5:** Control panel's air indicator flashing simultaneously on the left and right side (Airlinq Viva) or running from one side to the other (Airlinq Orbit).

Cause:

- Data connection to the unit (with communication ID ID0) is disconnected,
- Unit with communication ID ID0 is not connected to the power supply.

**Error 6:** Control panel's air indicator and half of all of the blue LEDs flashing alternately (Airlinq Viva).

Cause: Data connection from the control panel to its group master is disconnected.

**Error 7:** Control panel shows random warnings and/or alarms.

Cause: Data connection cable is connected to 12V, GND, A og B for all units. Connection must be corrected according to Appendix 1 of this manual.

**Error 8:** One or more of the units in the system cannot be seen on the communication bus with the Airlinq Service Tool, Airlinq User Tool program or on Airlinq Orbit.

Cause:

- Some units are not connected to the power supply,
- Data communication cables (A and B) are connected the wrong way round,
- Data connection to individual units is disconnected or not installed according to Appendix 1 of this manual.
- Communication ID or group ID for some units is programmed incorrectly,
- Jumper/switches for some units are not set according to Appendix 1 of this manual.

**Error 9:** All Airlinq Viva control panels and half of all of the blue LEDs flashing alternately and/or the Airlinq Orbit control panel is reporting an error.

Cause: Short circuit in the data communication between A and B.

**Error 10:** Control panel not working (no light in the panel).

Cause:

- 12 V and GND have been connected the wrong way round,
- 12 V and/or GND not connected or disconnected.

**Error 11:** Control panel not working (no light in the panel) or no data communication on the bus.

Cause: GND to the control panel is not connected or is disconnected.

**Error 12:** Unit stopped due to condensate alarm although there is no condensation in the condensate tray, and control panel not working (no light in the panel).

Cause: Short circuit between 12 V and GND.

**Error 13:** Group settings cannot be seen on one or more of the units with communication ID ID1, ID 2, ... ID 19.

Cause:

- Data connection is disconnected or not installed,
- Data communication cables (A and B) are connected the wrong way round,
- Communication ID or group ID for some units is programmed incorrectly,
- Some units are not installed according to the Airlinq BMS chart,
- Jumper/switches for some units are not placed correctly.

### **Error on Airlinq Digital BMS**

The associated Airlinq - Digital BMS manual is available on Airmaster's website: [www.airmaster-as.com](http://www.airmaster-as.com).

- This page is intentionally left blank -

# AIRMASTER

Airmaster A/S  
Industrivej 59  
9600 Aars  
Denmark

Tel.: +45 98 62 48 22  
info@airmaster-as.com  
www.airmaster-as.com/en/