

## Data Sheet AM 150

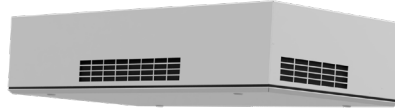

Technical data	Filter class	30 dB(A)	35 dB(A)	Boost
Maximum capacity <sup>1</sup>	ePM <sub>10</sub> 50%	106 m <sup>3</sup> /h	146 m <sup>3</sup> /h	225 m <sup>3</sup> /h
	ePM <sub>1</sub> 55%	84 m <sup>3</sup> /h	117 m <sup>3</sup> /h	206 m <sup>3</sup> /h
	ePM <sub>1</sub> 80%	80 m <sup>3</sup> /h	108 m <sup>3</sup> /h	190 m <sup>3</sup> /h
Throw (0,2 m/s) <sup>2</sup>	ePM <sub>10</sub> 50%	2,4 m	3,4 m	4,6 m
	ePM <sub>1</sub> 55%	2,0 m	2,7 m	4,2 m
	ePM <sub>1</sub> 80%	1,9 m	2,5 m	3,8 m
Supply air filter	ePM <sub>10</sub> 50%, ePM <sub>1</sub> 55% or ePM <sub>1</sub> 80%			
Extract air filter	ePM <sub>10</sub> 50%			
Dimensions (WxHxD)	1170 x 261 x 572 mm			
Weight, standard air handling unit, complete	53 kg			
Weight, casing	40 kg			
Weight, service cover	13 kg			
Colour, casing	RAL 9010 (white)			
Counterflow heat exchanger	PET (Polyethylene terephthalate)			
Energy class, cf. EU regulation no. 1254	SEC class A			
Air leakage classification cf. EN1886/EN13141-7	Class L1 / Class A1			
Air leakage classification, main damper, cf. EN1751	Class 3			
IP code	10			
Duct connection	Ø160 mm			
Condensate pump (capacity/lifting height at 5 l/h)	10 l/h / 6 m			
Condensate drain hose int./ext. diameter	Ø4 mm / Ø6 mm			
Supply voltage	220-240V/50Hz, ~1N+PE			
Maximum power consumption	373 W			
Maximum current	1,62 A			
Recommended fuse	0,55			
Maximum fuse	13 A (1 phase, type B). When using the cc module, it is type C			
Leakage current AC / DC	≤ 0,52 mA / ≤ 0,0007 mA			
Recommended residual current circuit breaker (RCCB)	Type B			
<b>Electrical heating surfaces</b>				
Heat output	500 W		1000 W <sup>3</sup>	
Nominal current	2,17 A		4,35 A	
Thermal circuit breaker, manual reset	100 °C		100 °C	

<sup>1</sup> All measurements were performed in normal operating mode in a standard installation using the facade grilles recommended by Airmaster, in a test room dimensioned 4.0 m x 4.0 m x 2.5 m with room attenuation of 7.5 dB. For larger rooms, e.g. 8.0 m x 10.0 m x 2.5 m, 2 dB must be deducted, i.e. sound pressure level for 2 dB higher can be used.

<sup>2</sup> The throw is measured with a 2 °C subcooled supply air at the standard setting of the inlet diffuser. The setting is adaptable, see page 7.

<sup>3</sup> Special item.

## Capacity with ePM<sub>10</sub> 50% / ePM<sub>10</sub> 50% filters

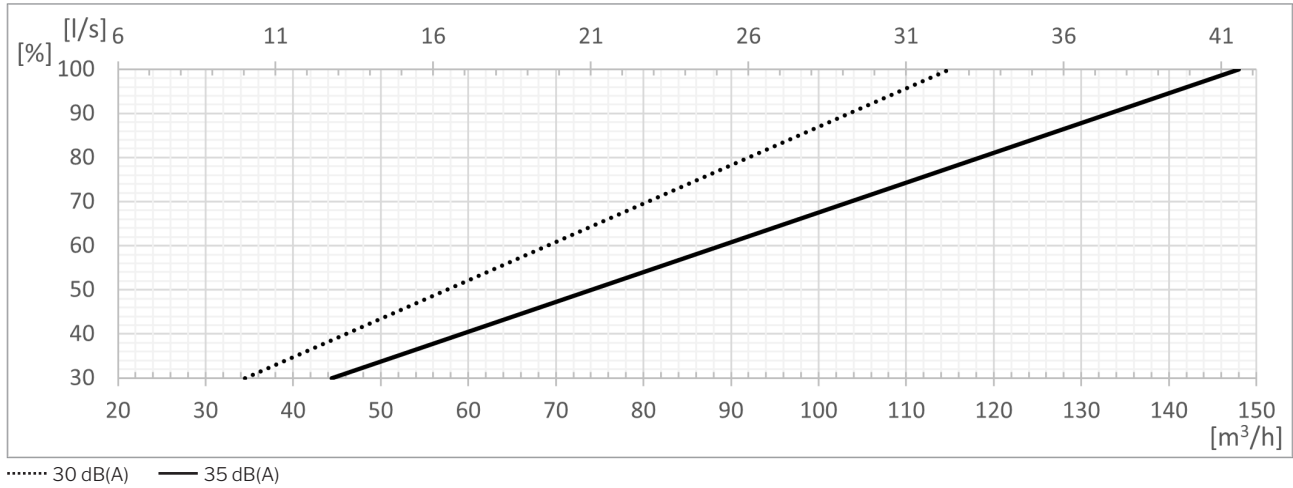

## Capacity with ePM<sub>1</sub> 55% / ePM<sub>10</sub> 50% filters

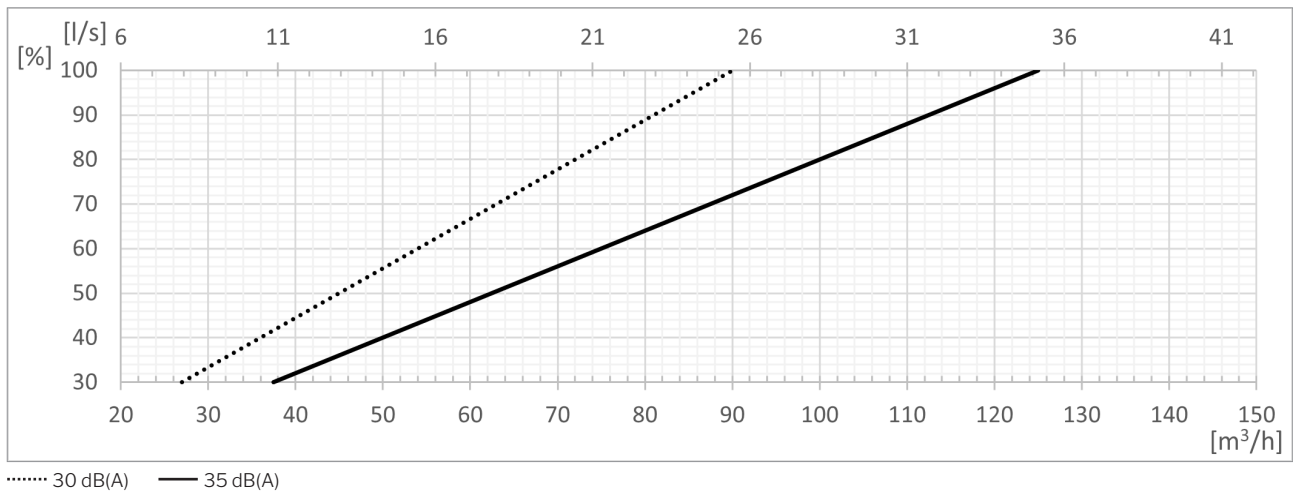

## Capacity with ePM<sub>1</sub> 80% / ePM<sub>10</sub> 50% filters

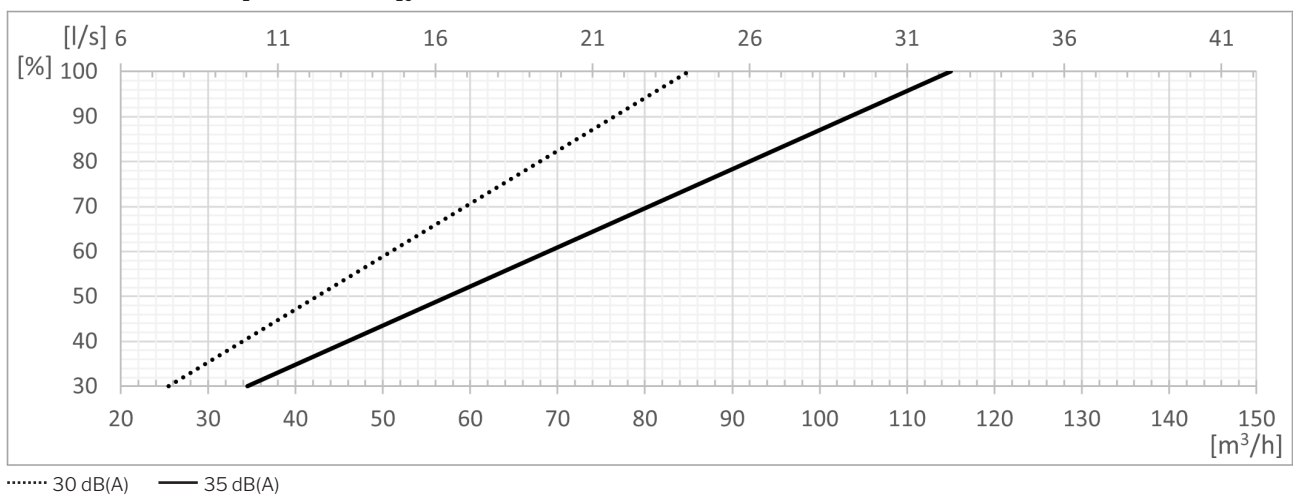

## SFP with ePM<sub>10</sub> 50% / ePM<sub>10</sub> 50% filters

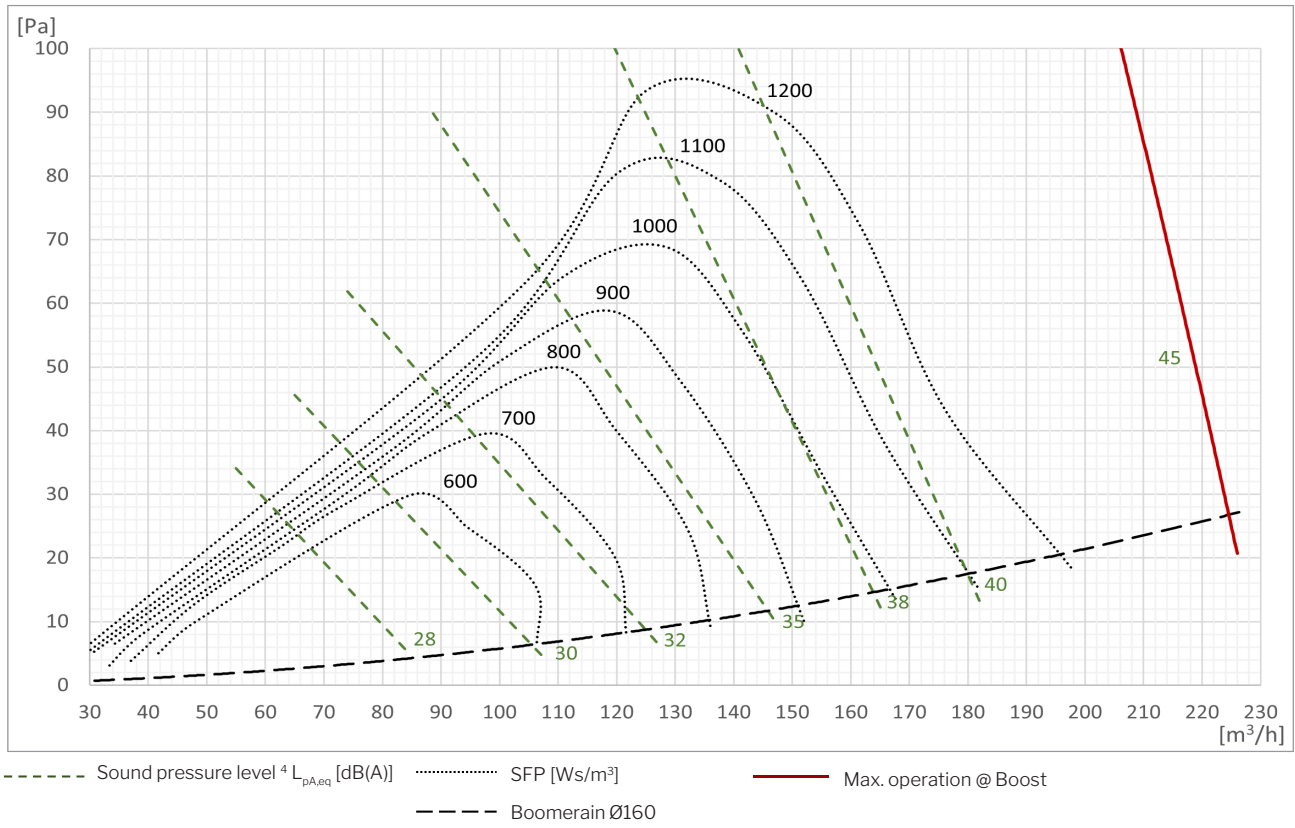

## SFP with ePM<sub>1</sub> 55% / ePM<sub>10</sub> 50% filters

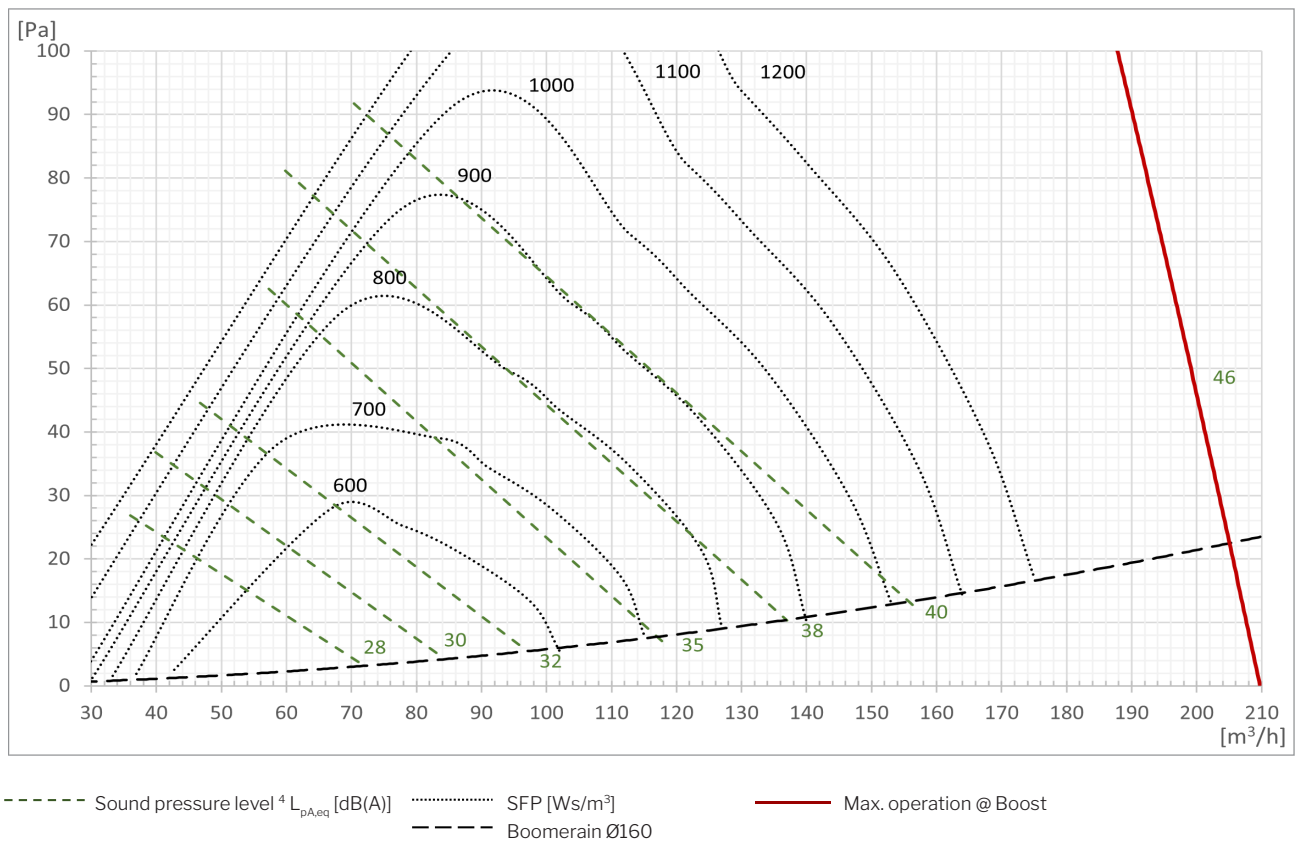

<sup>4</sup> The sound pressure level L<sub>pA,eq</sub> is measured at a height of 1,2 m at a horizontal distance of 1 m from the air handling unit.

## SFP with ePM<sub>1</sub> 80% / ePM<sub>10</sub> 50% filters

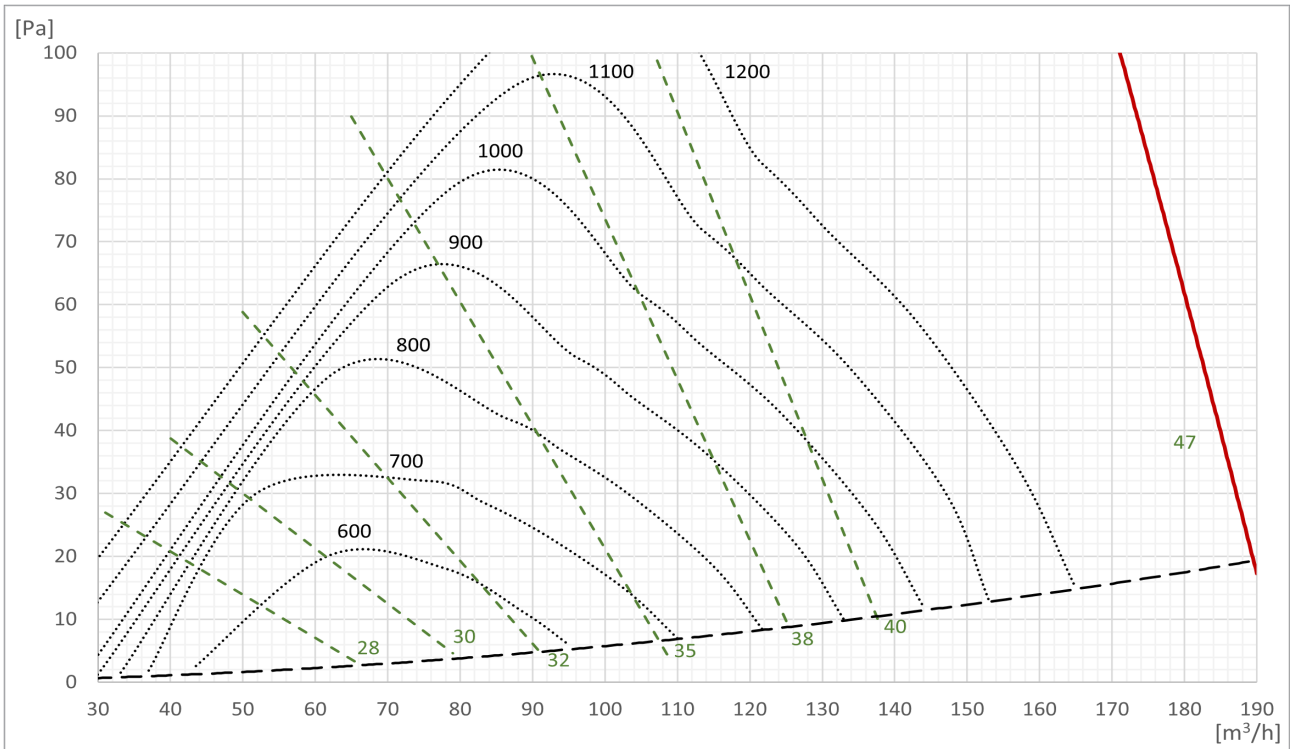

- - - Sound pressure level  $^4 L_{pA,eq}$  [dB(A)]    
 ..... SFP [Ws/m³]    
 — Max. operation @ Boost  
- - - Boomerain Ø160

## Sound pressure level $L_{pA,eq}$ acc. to Airmaster reference situation

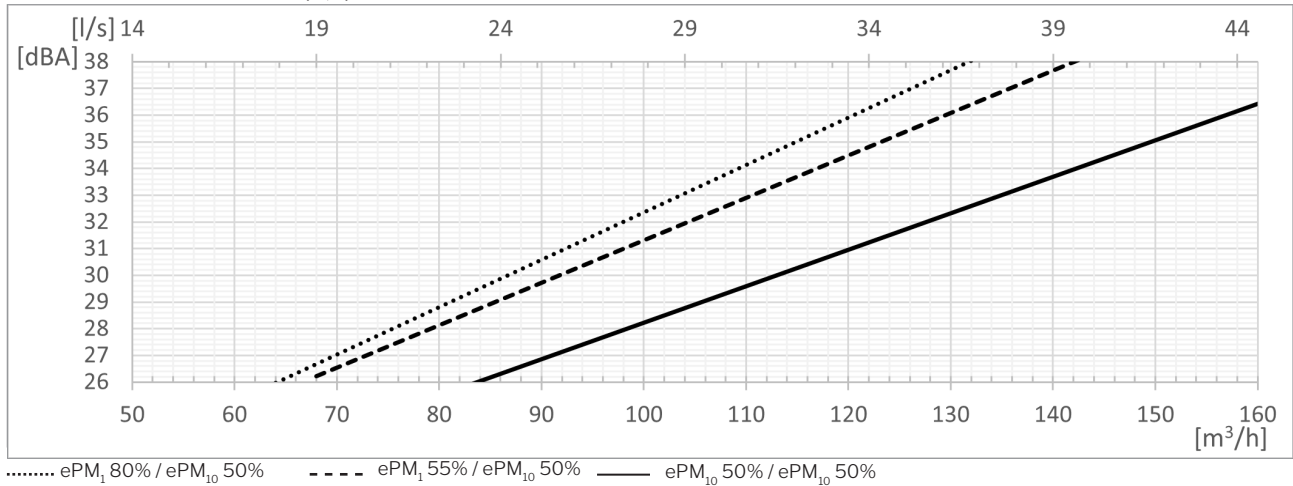

## Temperature efficiency acc. to EN 308

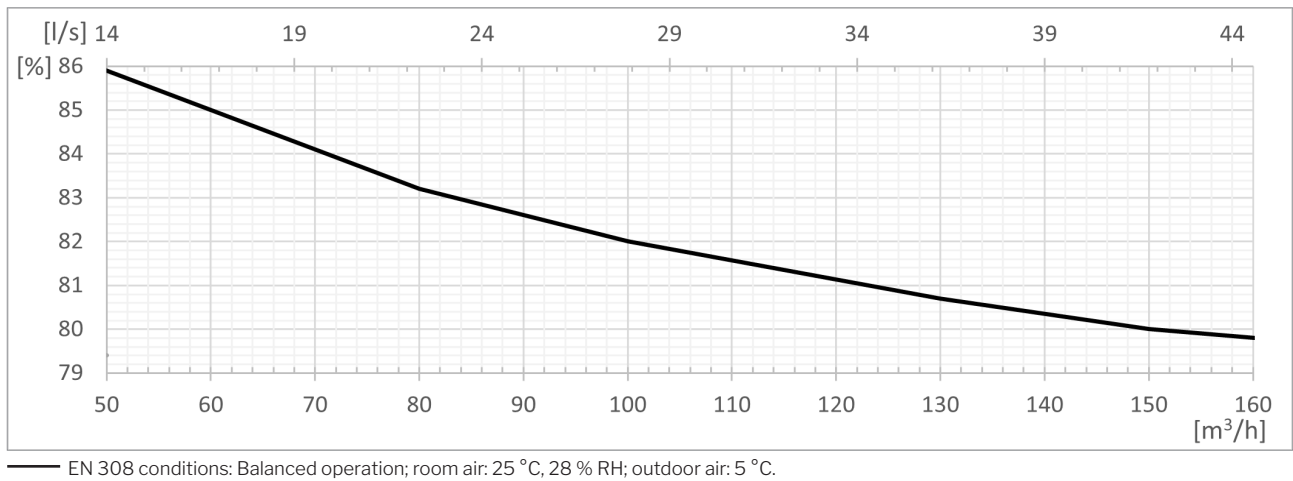

## Power consumption

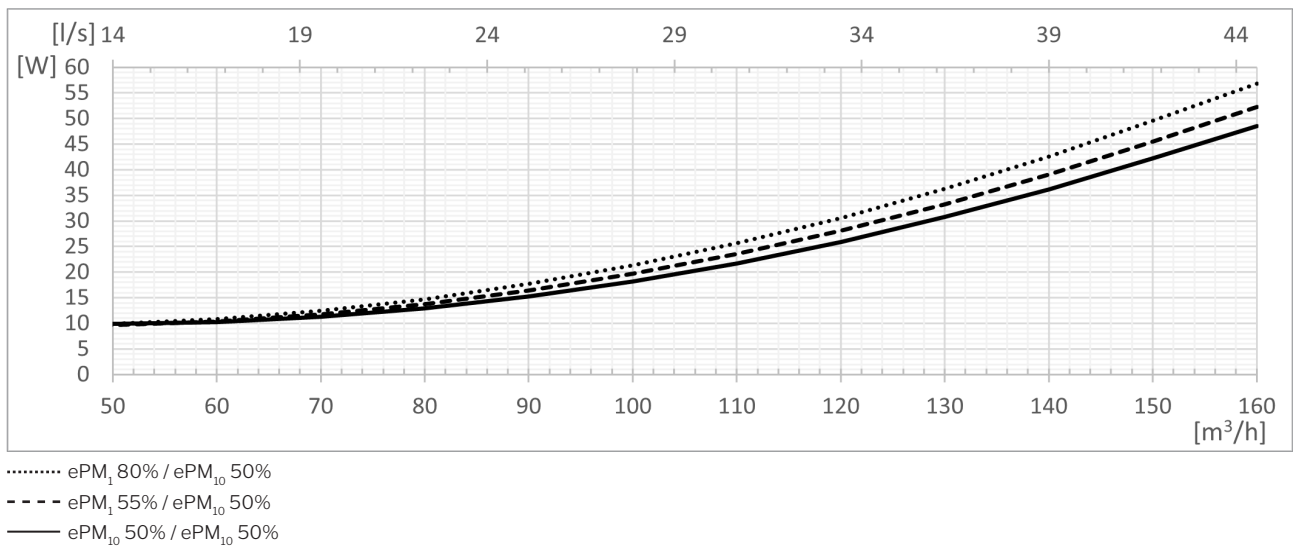

<sup>5</sup> The sound pressure level  $L_{pA,eq}$  is measured at a height of 1.2 m at a horizontal distance of 1 m from the air handling unit.

## SFP<sup>6</sup>

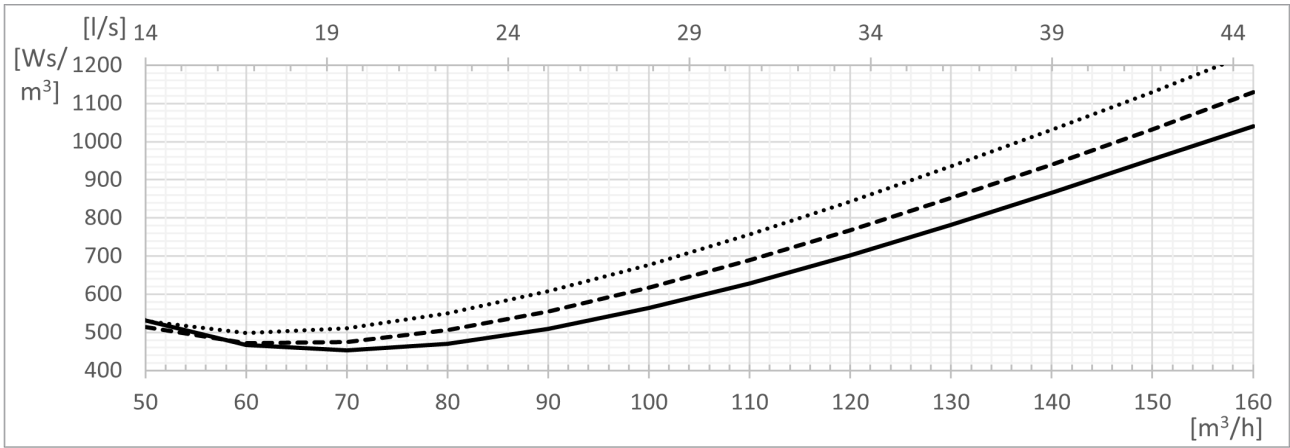

- ..... ePM<sub>1</sub> 80% / ePM<sub>10</sub> 50%
- - - ePM<sub>1</sub> 55% / ePM<sub>10</sub> 50%
- ePM<sub>1</sub> 50% / ePM<sub>10</sub> 50%

<sup>6</sup> The calculation of SFP includes the power consumption for operating fans but not for controls, display panel, etc.

## Throw<sup>7</sup> (0,2 m/s)

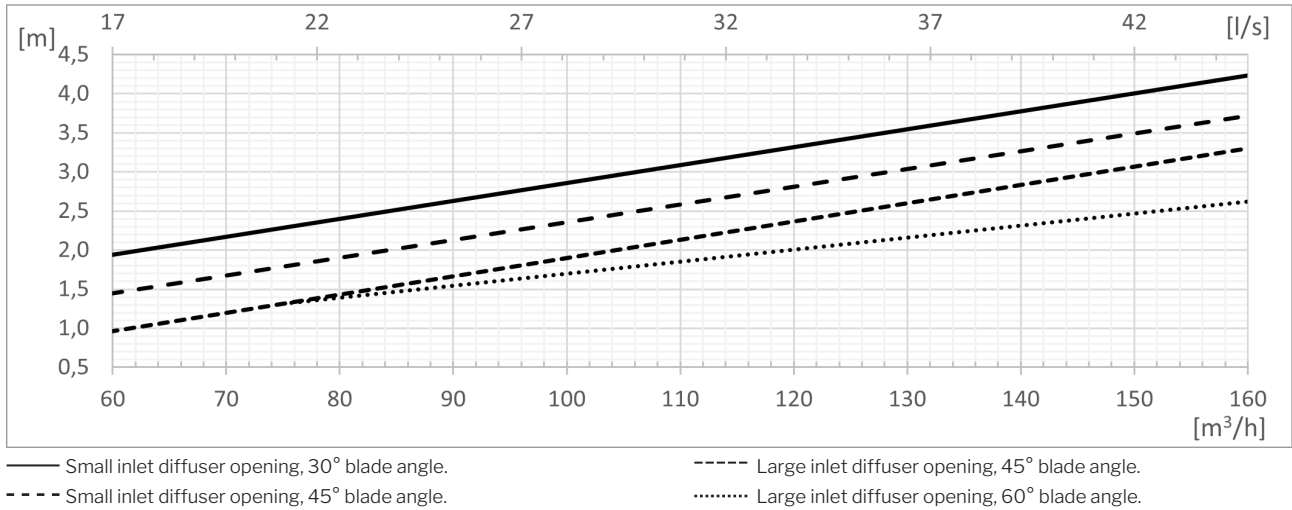

### Small and large inlet diffuser opening

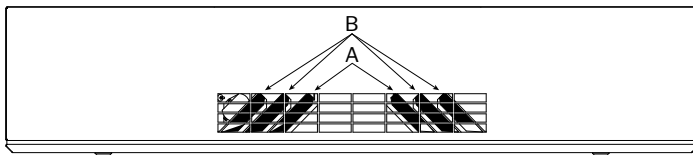

Small inlet diffuser opening:  
A is closed, B is open at  $x^\circ$ .

Large inlet diffuser opening:  
A and B are open at  $x^\circ$ .

Default delivery state:  
Small inlet diffuser opening, 45° blade angle.

### Throw and dispersion, top view.

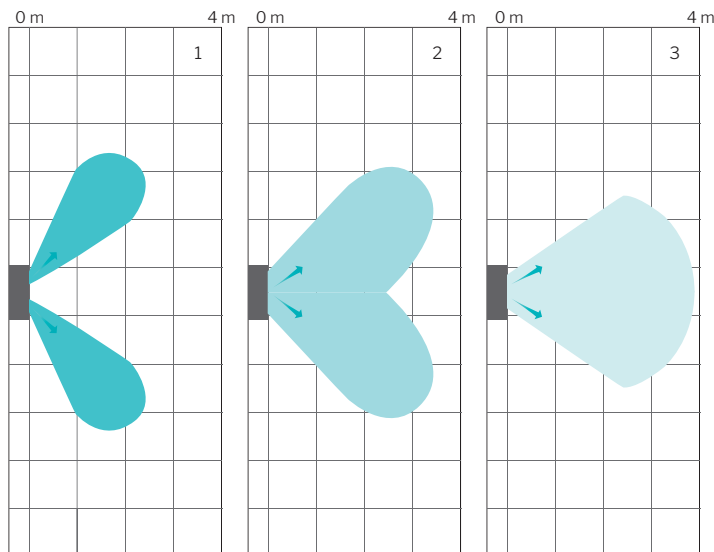

The air handling unit disperses inlet air depending on the blade angle settings.

The illustrations show the dispersion pattern and throw for the various blade angle settings at an air flow of 146 m³/h:

1. Large inlet diffuser opening, 60° blade angle.
2. Small inlet diffuser opening, 45° blade angle.
3. Small inlet diffuser opening, 30° blade angle.

Changing the air flow also affects the throw.

### Throw, side view.

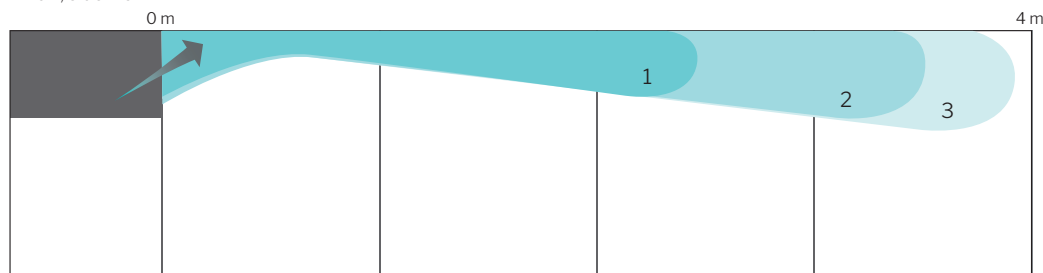

<sup>7</sup> The throw is measured with a 2 °C subcooled inlet air supply.

## Version overview AM 150

Exhaust/supply position  
» Back (**H**orizontal)

Inlet/extract position  
» Bottom (**B**)  
» Ducted Inlet (**DI**)  
» Ducted Extract (**DE**)

Mounting  
» Wall/ceiling bracket  
» Ceiling Frame (**CF**)

HH BB

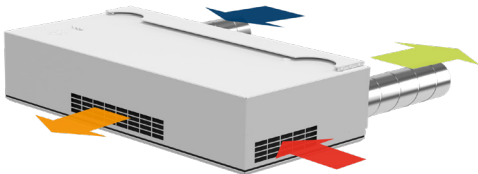

HHL BDE - CF<sup>8,9</sup>

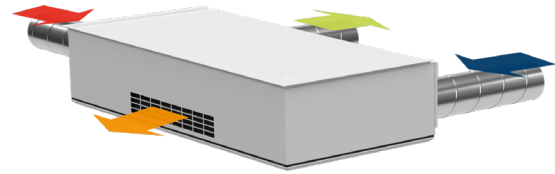

HH BDE

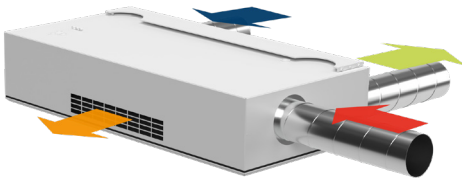

HH DIB<sup>8</sup>

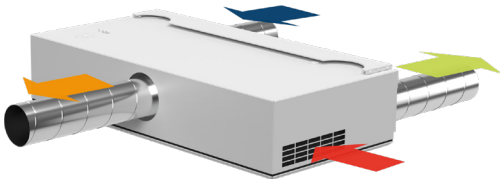

HH DIDE<sup>8</sup>

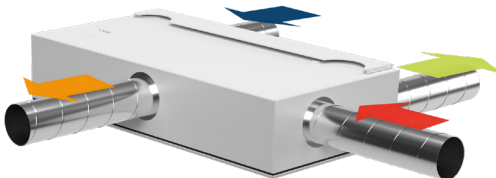

<sup>8</sup> Special item  
<sup>9</sup> L: Left model



## Standards and options

Counterflow heat exchanger (PET)	x
Enthalpy counterflow heat exchanger (polymer membrane)	o
Combination counterflow heat exchanger (polymer membrane)	o
Motor-driven bypass	x
Motor-driven supply air damper	x
Motor-driven extract air damper	x
Electric heating surface/VPH <sup>10</sup>	•
Condensate pump	•
Service power switch	•
Electronic humidity sensor (built-in)	•
PIR/motion sensor (wall mounted)	•
PIR/motion sensor (integrated)	•
CO <sub>2</sub> sensor (wall mounted)	•
CO <sub>2</sub> sensor (integrated)	•
TVOC (integrated)	•
CO <sub>2</sub> -/TVOC sensor (integrated)	•
Hygrostat (wall mounted)	o
Energy meter	•
Supply air filter ePM <sub>10</sub> 50%	•

Supply air filter ePM <sub>1</sub> 55%	•
Supply air filter ePM <sub>1</sub> 80%	o
Extract air filter ePM <sub>10</sub> 50%	x
LED (operating mode indicator)	x
Comfort cooling module	•
Wall/ceiling bracket	•
Ceiling frame	•
Operating button	•
Control panel, Viva	•
Control panel, Orbit	•
Airmaster Airlinq® Online	•
Airlinq® Online API	•
Airlinq® BMS	•
LON® module	o
KNX® module	o
MODBUS® RTU RS485 module	•
BACnet™ MS/TP module	•
BACnet™ /IP module	•

X : Standard    • : Optional    o : Special item (not stock item)

## Schematic sketch

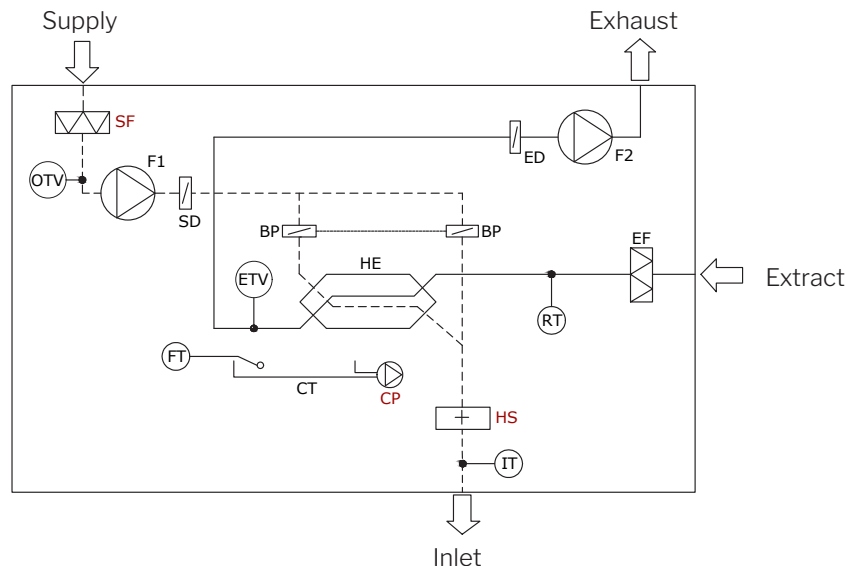

### Component designation

BP	Bypass damper (motor-driven)	FT	Float	OTV	Temperature sensor, Supply air ventilation
CP	Condensate pump (option)	F1	Supply air fan	RT	Temperature sensor, Room
CT	Condensate tray	F2	Extract air fan	SD	Supply air damper (motor-driven)
ED	Exhaust air damper (motor-driven)	HE	Counterflow heat exchanger	SF	Supply air filter (option)
EF	Extract air filter	HS	Electric heating surface (option)		
ETV	Temperature sensor, Exhaust, Ventilation	IT	Temperature sensor, Inlet-air		

<sup>10</sup> Virtual PreHeat